

# Faster and New SATA Flash Storage

The anti-vibration IEI SLC flash modules featured low power consumption, high performance and perfect reliability are best for SATA SSD and SATA DOM solutions. The SSD not only has much higher performance than the HDD, but also can be operated anytime due to the lack of moving parts such as motor, bearing or rotating head. In addition, the SSD is able to fulfill any specialized application in any harsh environment.

## Complete Industrial SLC Solution



Interface	SATA 1.5Gb/s	SATA 3Gb/s
Data Transfer Rate	SATA 6Gb/s	SATA 6Gb/s 3Gb/s
Reliability	Better	Better
Power Consumption	Lower	Lower
Heat Delivery	Better	Better
Chipset Support after 945G/GM	Yes	Yes

SLC vs. MLC Comparison Table

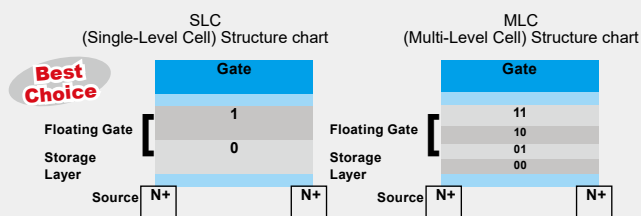

	SLC	MLC
Endurance (Erase cycle)	100,000	5,000-10,000
Operating Temp. Range	Support Wide Temp. -40°C~+85°C	0°C~+70°C
Power Consumption	Lower	Higher
Read/Write Performance	Better	Worse

## IEI SATA Flash Module Selection



Item	IFM-3010IS(WS)/IFM-3010IL(WL) IFM-3010IPS(WPS)	IFD-2530IS(WT)
Capacity	1GB~32GB	8GB~1TB
Interface	SATA 6Gb/s	SATA 6Gb/s
IDE Transfer Mode	PIO Mode 0-4 MwDMA Mode 0-2 UltraDMA Mode 0-2	PIO Mode 0-4 UltraDMA Mode 0-6
Data Transfer Rate	Read-300MB/sec. ; Write-130MB/sec.	Read-510MB/sec. ; Write-340MB/sec.
Operating Temp.	-0°C~+70°C ; -40°C~+85°C	IFD-2530IS: 0°C~+70°C ; IFD-2530WT: -40°C~+85°C
Storage Temp.	-55°C~+95°C	-55°C~+95°C
Humidity	10%~95%, non-condensing	10%~95%, non-condensing
Vibration	20G	20G (7~2000Hz)
Shock	1500G/10 ms	1500G/0.5 ms
ECC Technology	High reliability based on the internail ECC function	
MTBF	>3,000,000 hours	>3,000,000 hours
R/W Endurance	2,000,000 times	2,000,000 times
Wear-Leveing	Support	Support
DC Input Voltage	+5V single power supply operation	+5V single power supply operation
Power Mode	Auto stand-by and sleep mode	
Power Consumption	200 mA	
Enclosure Material	PC mechanical cover	Metal mechanical cover
Dimensions (WxLxH)	20.5 x 39.2 x 8 mm	69.8 x 100.1 x 9.3 mm
Certificate	RoHS / CE / FCC	

### Ordering Information

#### Industrial SATA Flash Card

Part No.	Interface	Capacity
IFM-3010IS-XXXX	Vertical SATA 6Gb/s 7 pin	1G~32G
IFM-3010WS-XXXX	Vertical SATA 6Gb/s 7 pin	1G~32G
IFM-3010IL-XXX	Vertical SATA 6Gb/s 7 pin	1G~32G
IFM-3010WL-XXXX	Vertical SATA 6Gb/s 7 pin	1G~32G
IFM-3010IPS-XXXX	Horizontal SATA 6Gb/s 7 pin	1G~32G
IFM-3010WPS-XXXX	Horizontal SATA 6Gb/s 7 pin	1G~32G

#### Industrial SATA 2.5" Flash Disk

Part No.	Interface	Capacity
IFD-2530IS-XXXX	SATA 6Gb/s 7+15 pin	8GB~1TB
IFD-2530WT-XXXX	SATA 6Gb/s 7+15 pin	32GB~1TB

XXXXX=Capacity-8GB/16GB/32GB/64GB/128GB/256GB/512GB/1TB  
 I= Standard grade operation temp.: 0°C~70°C  
 W=Industrial grade operation temp.: -40°C~85°C

# IEI Quick Mounting Technology

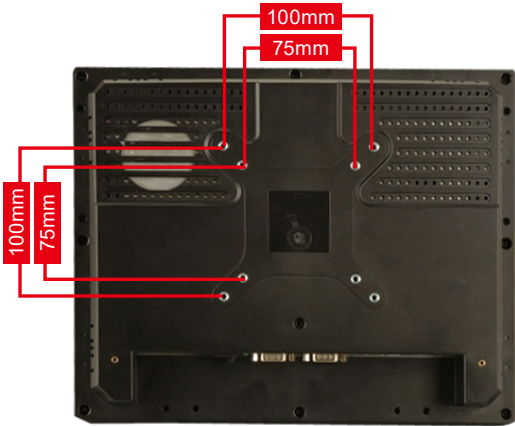

## Compliant with VESA Mounting Standards

IEI panel solutions have four mounting holes compliant with the VESA (Video Electronics Standards Association) mounting standard (75mm x 75mm/100mm x 100mm) on the rear panel for stand mounting and other mounting methods.

## » Stand Mounting

### • VESA 75/100 Universal Stand

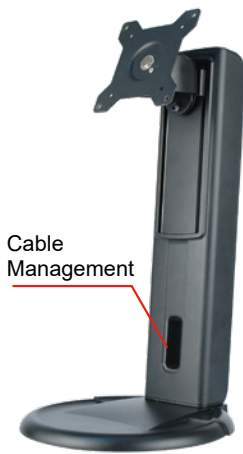

**STAND-A21-R10**



Portrait/Landscape



Height Adjustment (13 cm)



Right/Left Pan (360°)



Forward/Backward Tilt (+25°/-5°)

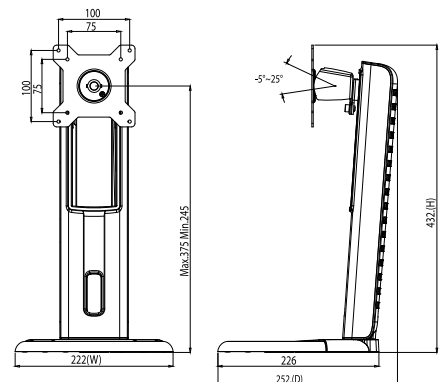
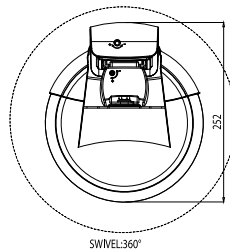

## Ordering Information

Part No.	Description
STAND-A21-R10	15"~21" VESA 75x75 mm/100x100 mm PPC/Monitor Stand, support from 6 KG to ~12 KG, Black, RoHS

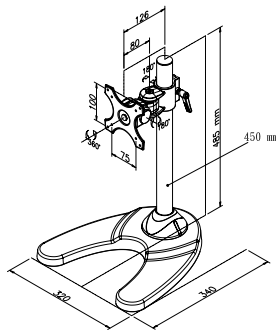

**STAND-210**

### Ordering Information

Part No.	Description
STAND-210-R11	<ul style="list-style-type: none"> <li>Support VESA 75/100 standard</li> <li>Weight capacity from 7kg~10kg</li> </ul>

### • VESA 75/100 Easy Stand

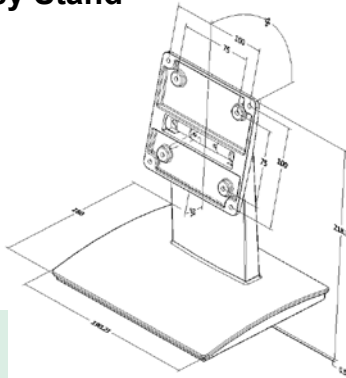

**STAND-C12-R10**

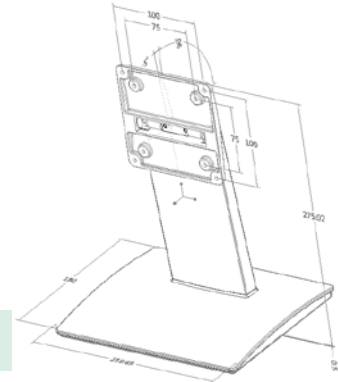

**STAND-C19-R10**



Tilt Forward/Backward

### Ordering Information

Part No.	Description
STAND-C12-R10	5.7" ~ 12.1" VESA 100x100mm, 75x75mm PPC/Monitor Stand, support up to 7.5kg, Black color, RoHS
STAND-C19-R10	15"~19" VESA 100x100mm, 75x75mm PPC/Monitor Stand, support up to 15kg, Blackcolor, RoHS

## DIN Rail Kit



Model Name	DK-75-R10	DK-100-R10
Specification	850 mm (W) x 75mm (D)	110 mm (W) x 100 mm (D)
Description	VESA 75 to DIN-rail kit	VESA 100 to DIN-rail kit

# » V-STAND

## VESA Multi-Mounting Stand

IEI patented multi-mounting V-Stand allows wall, ceiling, desk, rear and side mounting to meet diverse applications. Its 0° to 90° adjustable hinge design provides optimal viewing in various environments, such as kitchen, room or shelf.

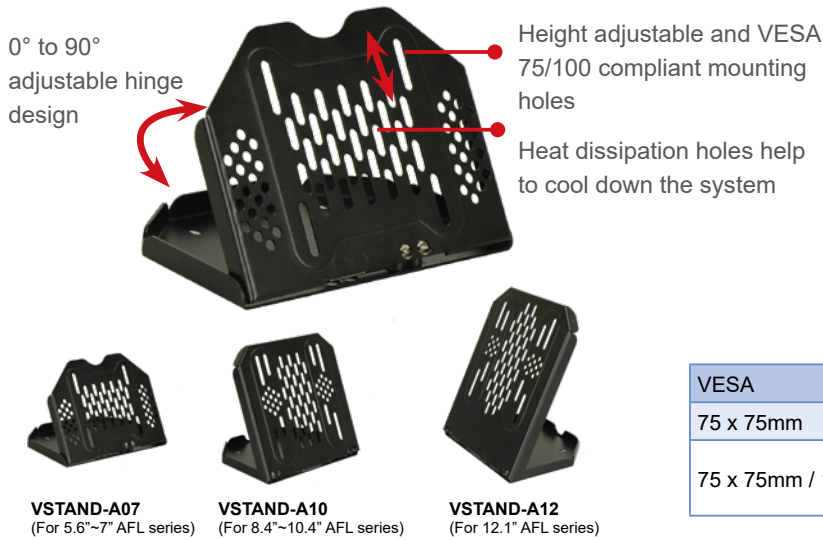

- Features:**
- 0° to 90° adjustable hinge design allows comfortable viewing
  - Standard VESA 75/100 compliance
  - Heat dissipation holes
  - Compact size, easy to use for mounting anywhere

VESA	Model
75 x 75mm	VSTAND-A07-R11
75 x 75mm / 100 x 100mm	VSTAND-A10-R11
	VSTAND-A12-R11

### A. One fits all solution

The V-Stand is a compact and tilt adjustable mounting stand providing mobility and ergonomic comfort to fit common wall mounting and ceiling mounting situations.



### B. 0° to 90° excellent adjustability

You can change the angle of the stand from 0° to 90° to reach almost any point with ergonomic features for comfortable viewing.



### C. Space saving and easy installation

Compact size provides mobility





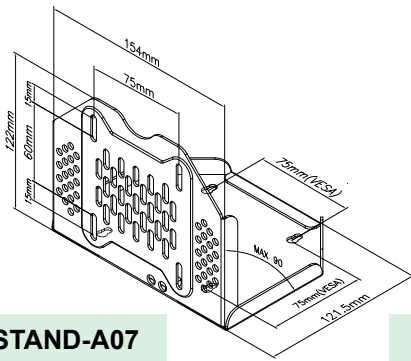

VSTAND-A07

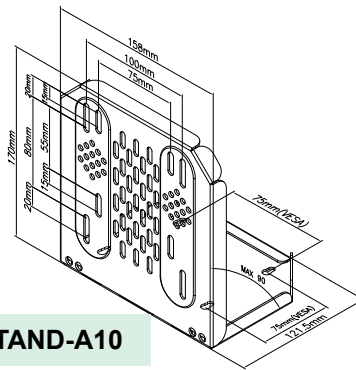

VSTAND-A10

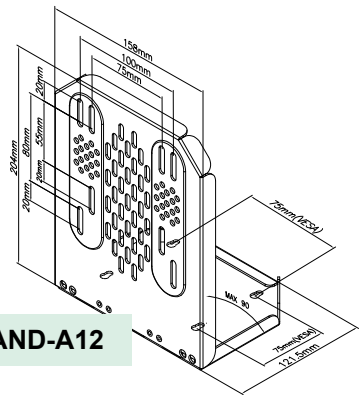

VSTAND-A12

## Ordering Information

Part No.	Description
VSTAND-A07-R11	LCD monitor / PPC stand V type, for AFL series, VESA 75, 0°~90° degree adjustable hinge, support up to 2.5 kg, RoHS
VSTAND-A10-R11	LCD monitor / PPC stand V type, for AFL series, VESA 75/100, 0°~90° degree adjustable hinge, support up to 3 kg, RoHS
VSTAND-A12-R11	LCD monitor / PPC stand V type, for AFL series, VESA 75/100, 0°~90° degree adjustable hinge, support up to 3.5 kg, RoHS

## ARM

### VESA 75/100 Desk ARM

VESA	Model
75x75mm/100x100mm	ARM-11-RS
	ARM-31-RS

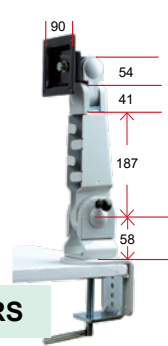

ARM-11-RS

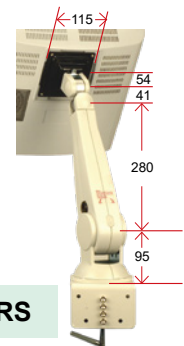

ARM-31-RS

## Ordering Information

Part No.	Description
ARM-11-RS	LCD Monitor / PPC ARM, VESA 75/100, 3kg~6kg, RoHS
ARM-31-RS	LCD Monitor / PPC ARM, VESA 75/100, 7kg~14kg, RoHS

## Wall Mounting

### VESA 75/100 Wall Mounting

VESA	Model
75x75mm/100x100mm	AFLWK-12
	AFLWK-19B

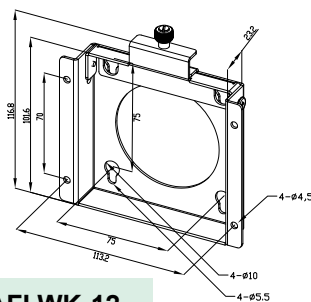
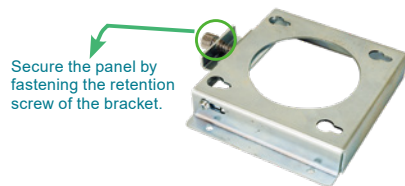

AFLWK-12

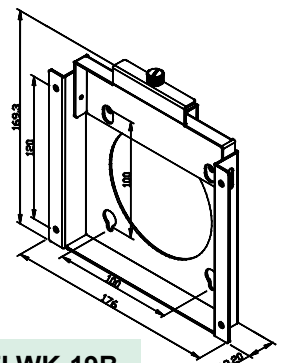

AFLWK-19B

## Ordering Information

Part No.	Description
AFLWK-12	5.6"~12" VESA 75x75mm PPC/Monitor Wall Mount Kit with Retention Screw, Silver color, RoHS
AFLWK-19B	15"~19" VESA 100x100mm PPC/Monitor Wall Mount Kit with Retention Screw, Silver color, RoHS

# Power Supply

IEI power supply solutions are complete and flexible. Normal (PS2, 1U, 2U) or redundant form, close or open frame, DC or AC input, AT or ATX model, 10 to 600 watts or higher, all of these features are available within a reliable and highly efficient power solution.

IEI's embedded system power supply solution is efficient and stable. IEI also provides customized power supply services to meet your demands.

## » Selection

### ■ 1U Series

- 1U Chassis



### ■ 2U Series

- 1U ~ 2U Chassis



### ■ PS2 Series

- 2U ~ 4U Chassis



### ■ Redundant

- 2U ~ 4U Chassis



### ■ Adapter

- LCD Monitor
- AFL Series
- Embedded System



### ■ DC to DC Module

- Battery Backup System
- Embedded System
- Mobile Auto Solution

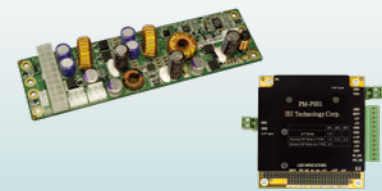

AC-DC Adapter

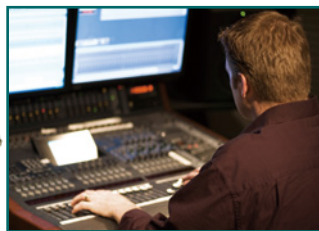

Type	Temperature
AC-DC Adapter	0°C ~ 40°C

### Current

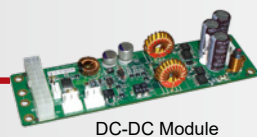

## » Wide Temperature

### Medical

Item	Model	Watt	AC/DC
PS/2	ACE-4840APM	400W	AC

### -20°C ~ 70°C

Item	Model	Watt	AC/DC
PS/2	ACE-160B	600W	AC
	ACE-A140B	400W	AC

## » 80 PLUS & ErP

### ■ 80 PLUS

The 80 PLUS power supply saves energy and money to keep up with the latest market trends.

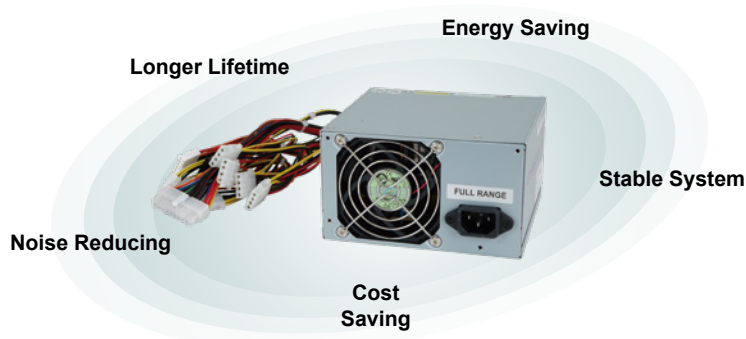

### Efficiency Trend

Multiple output for computers and servers Eff. ≥ 80% at 20%, 50% and 100% of rated load PFC ≥ 0.9

	80 PLUS	80 PLUS BRONZE	80 PLUS SILVER	80 PLUS GOLD
20% (loading)	80%	82%	85%	87%
50% (loading)	80%	85%	88%	87%
100% (loading)	80%	82%	85%	87%

#### ■ Energy Saving

A high efficiency power supply saves energy by reducing the amount of energy used during the current transferring process.

#### ■ System Reliability

Reducing the heat output helps to lower the system temperature and increase system reliability.

#### ■ Cost Saving

A high efficiency power supply reduces energy consumption, which means savings on your electric bills.

#### ■ Noise Reducing

A high efficiency power supply can achieve a lower operating temperature. When the fan operates at a lower speed, it produces less noise.

#### ■ Longer Lifetime

A high efficiency power supply can reduce heat generated inside the power supply and increase its operating hours.

### ■ ErP

#### ErP → Energy-Related Products

These products are aimed at improving energy efficiency and reducing energy consumption.

**Scope:** Anything that is Class B EMC (Class A out of scope)

#### Power Supply

Off mode & Standby mode

Off mode	≤ 1.0 W
Standby mode	≤ 1.0 W



#### Adapter









Maximum Energy Consumption in No-Load Mode

Output power	AC-DC external power supplies, except low voltage external power supplies	Low voltage external power supplies
≤ 51W	0.30W	0.30W
Po > 51W	0.50W	N/A

# 1U/2U Type Selection Guide

- **Safety (ITE Standard)** - CB IEC 62368, UL 62368, CSA C 22.2 No. 62368 ,TUV EN 62368
- **Safety (Medical Standard)** - CB IEC 60601, UL 60601, CSA C 22.2 No. 60601, TUV EN 60601
- **EMI** - Meets EN 55032, FCC Part 15, CISPR 32 Meets EN 61000-3-2, EN 61000-3-3 (PFC function)
- **EMS** - Meets EN 55024, EN 61000-4-2/3/4/5/6/8/11

\* For detailed specs, please refer to official certification

1U AC Input															
Products	Model No.	Watt AT/ ATX PFC	Input Range Voltage	Output Current Range							Efficiency	ErP	Operating Temperature	Safety	Dimensions (mm)
				+3.3 V	+5 V	+12 V	-5 V	-12 V	+5 Vsb	+24 V					
	ACE-A630C	300W ATX -	90 ~ 265 VAC	12 A (0 A)	14 A (0 A)	25 A (0.1 A)		0.5 A		3 A	 87%	V	0°C ~ 50°C	CB/UL/ TUV/ CCC/ CE/FCC	150 x 81.5 x 40.5
	ACE-A622C	220W ATX -	90 ~ 264 VAC	10 A (0.1 A min.)	14 A (0.2 A min.)	14 A (0.6 A min.)		0.3 A		2.5 A	 85%	V	0°C ~ 50°C	CB/UL/ TUV/ CCC/ CE/FCC	150 x 81.5 x 40.5
	ACE-A618C	180W ATX -	90 ~ 264 VAC	10 A (0.1 A min.)	14 A (0.2 A min.)	10 A (0.6 A min.)		0.3 A		2.5 A	 85%	V	0°C ~ 50°C	CB/UL/ TUV/ CCC/ CE/FCC	150 x 81.5 x 40.5
	ACE-A615C	150W ATX -	90 ~ 264 VAC	10 A (0.1 A min.)	14 A (0.2 A min.)	10 A (0.6 A min.)		0.3 A		2.5 A	 85%	V	0°C ~ 50°C	CB/UL/ TUV/ CCC/ CE/FCC	150 x 81.5 x 40.5
1U DC Input															
Products	Model No.	Watt AT/ ATX PFC	Input Range Voltage	Output Current Range							Efficiency	Operating Temperature	Safety	Dimensions (mm)	
				+3.3 V	+5 V	+12 V	-5 V	-12 V	+5 Vsb	+24V					
	ACE-A4520D	250W ATX -	24 VDC (18 ~ 36 VDC)	10 A	14 A	18 A (0.05A min.)		0.3 A		2.5 A	80%		0°C ~ 50°C	CB UL TUV CCC NEMKO CE FCC	150 x 81.5 x 40.5

# 1U AC Input ATX Type

## ACE-A630C

1U Flex ATX 300 W Power Supply



### Specifications

Input Type	90~264VAC Full Range				
Output Voltage	+3.3 V 12 A (0 A)	+5 V 14 A (0 A)	+12 V 25 A (0.1 A)	-12 V 0.3 A	+5 Vsb 3 A
Efficiency	87%				
Temperature	Operating: 0°C ~ 50°C, Storage: -40°C ~ 80°C				
MTBF (hrs)	100,000				
Output Connector	20+4-pin ATX, 4-pin 12V CPU, 1 x FDD, 1 x HDD, 2 x SATA, 2 x Graphics card power				
Dimensions (mm)	150 x 81.5 x 40.5				

### Dimensions (Unit: mm)

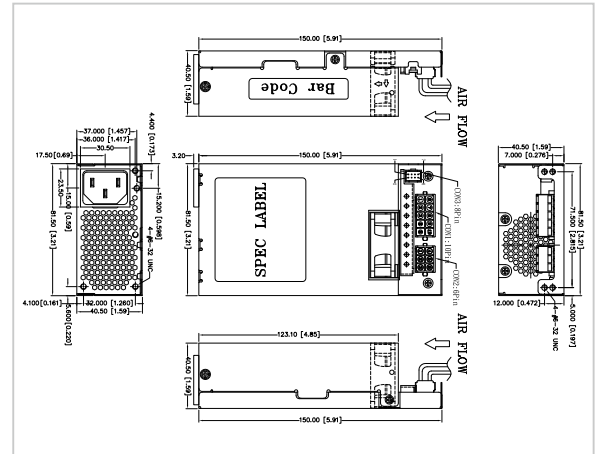

### Ordering Information

Part No.	Description
ACE-A630C-R10	1U Flex ATX 300W Power Supply, 90~264 VAC, ErP, CCL, RoHS

## ACE-A622C

220 W 1U Type ATX Power Supply



### Specifications

Input Type	90~264 VAC Full Range						
Output Voltage	+3.3 V 10 A (0.1 A min.)	+5 V 14 A (0.2 A min.)	+12 V 14 A (0.6 A min.)	+12 V 2	-12 V 0.3 A	+5 Vsb 2.5 A	+5 Vsb 2.5 A
Efficiency	85%						
Temperature	Operating: 0°C ~ 50°C, Storage: -20°C ~ 80°C						
MTBF (hrs)	100,000						
Output Connector	20+4-pin ATX, 4-pin 12V CPU, 2 x HDD, 2 x SATA, 1 x Graphics card power						
Dimensions (mm)	150 x 81.5 x 40.5						

### Dimensions (Unit: mm)

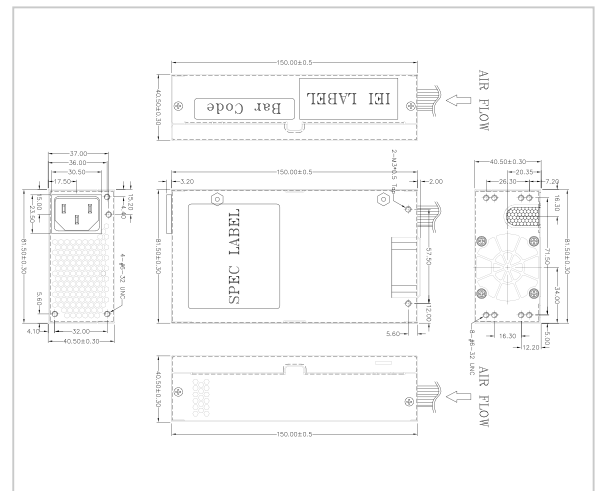

### Ordering Information

Part No.	Description
ACE-A622C-R10	1U Flex ATX 220W Power Supply, 90~264VAC, ErP, CCL, RoHS



# ACE-A618C

180 W 1U Type ATX Power Supply



## Specifications

Input Type	90~264 VAC Full Range				
Output Voltage	+3.3 V	+5 V	+12 V	-12 V	+5 Vsb
	10 A (0.1 A min.)	14 A (0.2 A min.)	10 A (0.6 A min.)	0.3 A	2.5 A
Efficiency	85%				
Temperature	Operating: 0°C ~ 50°C, Storage: -20°C ~ 80°C				
MTBF (hrs)	100,000				
Output Connector	20+4-pin ATX, 4-pin 12V CPU, 1 x FDD, 1 x HDD, 2 x SATA				
Dimensions (mm)	150 x 81.5 x 40.5				

## Dimensions (Unit: mm)

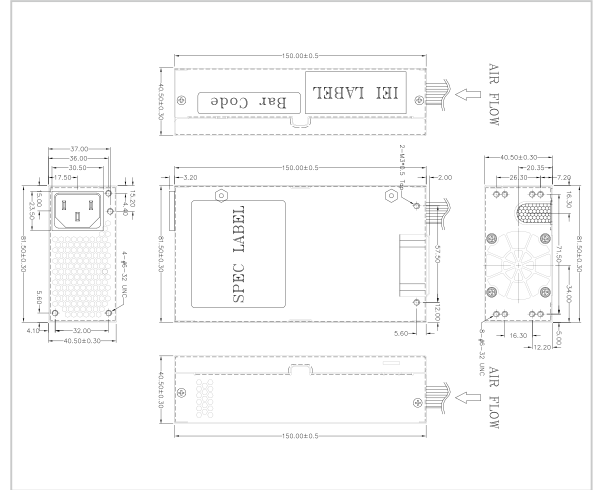

## Ordering Information

Part No.	Description
ACE-A618C-R10	1U Flex ATX 180W Power Supply, 90~264VAC, ErP, CCL, RoHS

# ACE-A615C

150 W 1U Type ATX Power Supply



## Specifications

Input Type	90~264 VAC Full Range				
Output Voltage	+3.3 V	+5 V	+12 V	-12 V	+5 Vsb
	10 A (0.1 A min.)	14 A (0.2 A min.)	10 A (0.6 A min.)	0.3 A	2.5 A
Efficiency	85%				
Temperature	Operating: 0°C ~ 50°C, Storage: -20°C ~ 80°C				
MTBF (hrs)	100,000				
Output Connector	20+4-pin ATX, 4-pin 12V CPU, 1 x FDD, 2 x HDD, 2 x SATA				
Dimensions (mm)	150 x 81.5 x 40.5				

## Dimensions (Unit: mm)

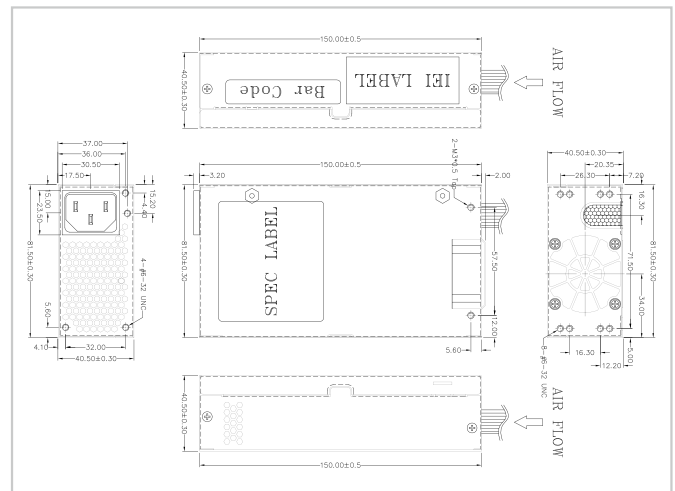

## Ordering Information

Part No.	Description
ACE-A615C-R10	1U Flex ATX 150W Power Supply, 90~264VAC, ErP, CCL, RoHS

# 1U AC Input AT Type

## ACE-716AP

150 W 1U Type AT Power Supply



### Specifications

Input Type	85 ~ 265 VAC Full Range (ACE-716AP)			
Output Voltage	+5V	+12V	-5V	-12V
	18 A (1 A min.)	4 A	0.5 A	1 A
Efficiency	75%			
Temperature	Operating: -20°C ~ 70°C (50°C ~ 70°C derating curve) Storage: -20°C ~ 85°C			
MTBF (hrs)	149,000			
Output Connector	Optional cable			
Dimensions (mm)	198 x 97 x 40.5			

### Dimensions (Unit: mm)

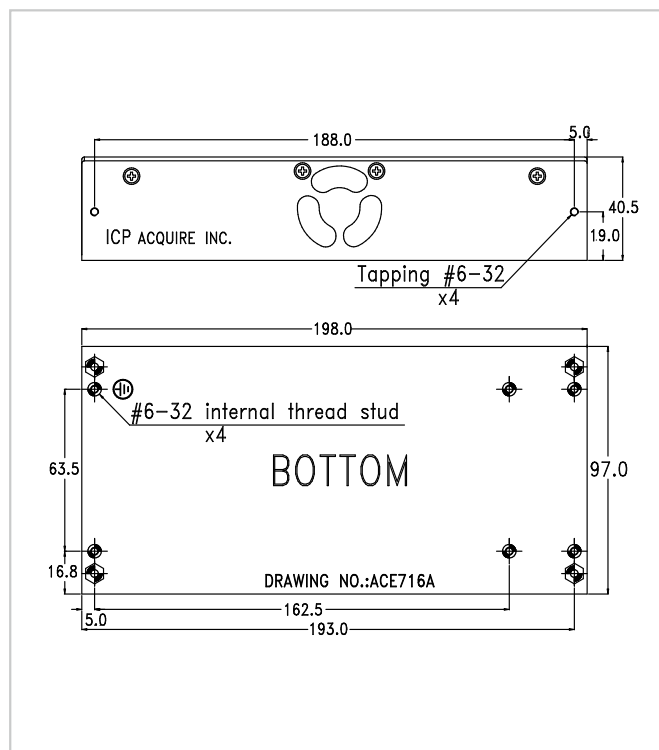

### Ordering Information

Part No.	Description
ACE-716AP-RS	150W AC-DC AT Power Supply, with PFC

# ACE-A4520D

250 W 24V DC input 1U ATX Power Supply



**High power capacity 250W in 1U size!!**

**Meets ATX revision 2.0 with 20+4-pin ATX power and SATA**



## Specifications

Input	Voltage	18 ~ 36 VDC input		
	Input Current	15 A (RMS) @ -24 VDC		
	Inrush Current	18 A max. for -24 VDC		
Output	Voltage	Min. Load	Max. Load	Ripple & Noise
	+5 V	0 A	14 A	50 mV P-P
	+12 V	0.05 A	18 A	120 mV P-P
	-12 V	0 A	0.3 A	120 mV P-P
	+3.3 V	0 A	10 A	50 mV P-P
	+5 Vsb	0 A	2.5 A	50 mV P-P
	+3.3V, +5V, +12V total current not exceed 184W			
Protection	Overvoltage Protection	+5 V output: 5.7 V ~ 6.5 V +12 V output: 13.3 V ~ 15.5 V +3.3 V output: 3.7 V ~ 4.5 V		
	Over Circuit Protection	+5 V output: 18 V ~ 22 V +12 V output: 20 V ~ 26 V +3.3 V output: 15 V ~ 20 V		
	Short Circuit Protection	+3.3 V, +5 V, +12 V shut down and latch off		
General Specifications	Output Rise Time	20 ms max.		
	Efficiency	80%		
	MTBF	100,000 hours on max. load at +25°C		
	Temperature	Operating: 0°C ~ 50°C Storage: -20°C ~ 80°C		
	Relative Humidity	5% ~ 95% RH non-condensing		
	Output Connector	20+4-pin ATX, 4-pin 12 V CPU, FDD, SATA, 2 x HDD		

## Features

- High efficiency
- Low ripple & noise
- Output overvoltage protection
- Short circuit protection on all output
- 100% burn-in under high ambient temperature (50°C)
- Vacuum-impregnated transformer
- MTBF: 100K hours at 25°C
- 100% hi-pot tested
- Line input fuse protection

## Dimensions (Unit: mm)

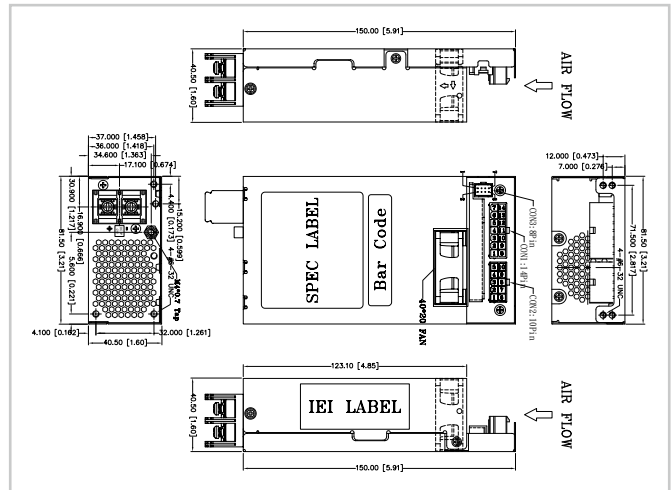





## Ordering Information

Part No.	Description
ACE-A4520D-R10	250W 24 V DC Input 1U ATX Power Supply

# PS/2 Selection Guide

- **Safety (ITE Standard)** - CB IEC 62368, UL 62368, CSA C 22.2 No. 62368 ,TUV EN 62368
- **Safety (Medical Standard)** - CB IEC 60601, UL 60601, CSA C 22.2 No. 60601, TUV EN 60601
- **EMI** - Meets EN 55032, FCC Part 15, CISPR 32 Meets EN 61000-3-2, EN 61000-3-3 (PFC function)
- **EMS** - Meets EN 55024, EN 61000-4-2/3/4/5/6/8/11

\* For detailed specs, please refer to official certification

AC Input													
Product	Model No.	Watt AT/ATX PFC	Input Range	Output Current Range						Efficiency	ErP	Operating Temperature	Safety
			Voltage	+3.3 V	+5 V	+12 V	-5 V	-12 V	+5 Vsb				
	<b>ACE-A160B</b>	600W ATX PFC	90~264 VAC	25 A (0 A)	25 A (0.2 A)	V1: 16 A (0.05 A) V2: 16 A (0 A) V3: 16 A (0 A) V4: 16 A (0 A)	0.5 A (0 A)	0.5 A	4 A	 82%	v	0°C ~ 50°C	CB / UL / TUV CCC / CE / FCC
	<b>Medical ACE-4840APM</b>	400W ATX PFC	90 ~ 265 VAC	30 A (0.5 A min.)	30 A (0.3 A min.)	V1: 17 A (1 A min.) V2: 17 A (1 A min.)	0.3 A	0.8 A	2 A	68%		0°C ~ 50°C	CB / UL CCC / VDE
	<b>ACE-A140B</b>	400W ATX PFC	90 ~ 264 VAC	21 A (0 A)	16 A (0.2 A)	V1: 17 A (0.05 A) V2: 17 A (0 A)	0.1 A (0 A)	0.5 A	3 A	 87%	v	-5°C ~ 50°C	CB / UL / TUV CCC / CE / FCC
	<b>ACE-A140B-S</b>	400W ATX PFC	90 ~ 264 VAC	21 A (0 A)	16 A (0.2 A)	V1: 17 A (0.05 A) V2: 17 A (0 A)	0.1 A (0 A)	0.5 A	3 A	 87%	v	-5°C ~ 50°C	CB / UL / TUV CCC / CE / FCC
	<b>ACE-A130C</b>	300W ATX PFC	90 ~ 264 VAC	19 A (0 A)	16 A (0.2 A)	V1: 17 A (0.05 A) V2: 17 A (0 A)	0.1 A (0 A)	0.5 A (0 A)	3 A (0 A)	 87%	v	0°C ~ 50°C	CB / UL / TUV CCC / CE / FCC
	<b>ACE-A130C-S</b>	300W ATX PFC	90 ~ 264 VAC	19 A (0 A)	16 A (0.2 A)	V1: 17 A (0.05 A) V2: 17 A (0 A)	0.1 A (0 A)	0.5 A (0 A)	3 A (0 A)	 87%	v	0°C ~ 50°C	CB / UL / TUV CCC / CE / FCC

# PS/2 AC Input ATX Type

## ACE-A160B

600W PS/2 ATX Power Supply with ErP

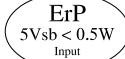
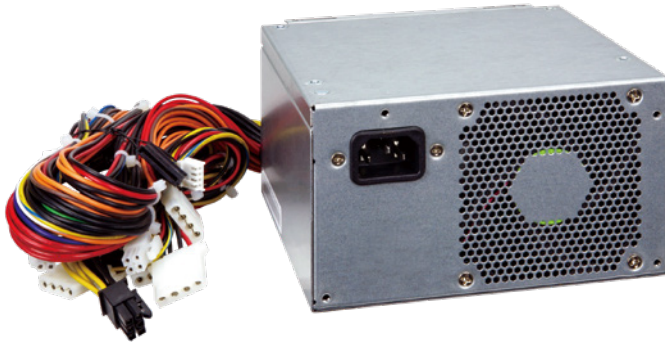

### Ordering Information

Part No.	Description
ACE-A160B-R10	600W PS/2 ATX Power Supply with ERP, RoHS

### Specifications

Input	Voltage	90~265 VAC Full Range		
	Frequency	47 Hz ~ 63 Hz		
	Input Current	10A (RMS)@115VAC, 5A (RMS)@230VAC		
	Inrush Current	40A max. for 115VAC, 80A max. for 230VAC		
Output	Voltage	Min. load	Max. load	Ripple & Noise
	+3.3V	0 A	25 A	50mV
	+5V	0.2 A	25 A	50mV
	+12V1	0.05 A	16 A	120mV
	+12V2	0 A	16 A	120mV
	+12V3	0 A	16 A	120mV
	+12V4	0 A	16 A	120mV
	-12V	0 A	0.5 A	120mV
	+5VSB	0 A	4.0 A	50mV
	-5V	0A	0.5A	50mV

Maximum continuous combined load on +3.3VDC and +5VDC outputs shall not exceed 150W.

Maximum continuous total DC output power should not exceed 600W

Over Voltage Protection	5V: 5.7V-6.5V 12V1 ~ 12V4: 13.3V-16.7V 3.3V: 3.9V-4.5V
Short Circuit Protection	3.3V, 5V, +12V1, +12V2, +12V3, +12V4, -12V, -5V shutdown and latch off
Watt	600W
PFC	Active
Hold-up Time	16 ms min.
Efficiency	82%
MTBF	100,000 hours
Temperature	Operating: 0°C ~ 50°C, Storage: -20°C ~ 80°C
Dimensions (mm)	140 x 150 x 86
Output Connector	1 x 20+4-pin ATX, 1 x 4-pin 12V CPU, 9 x HDD/CDROM, 1 x Graphics card power, 2 x SATA

### Dimensions (Unit: mm)

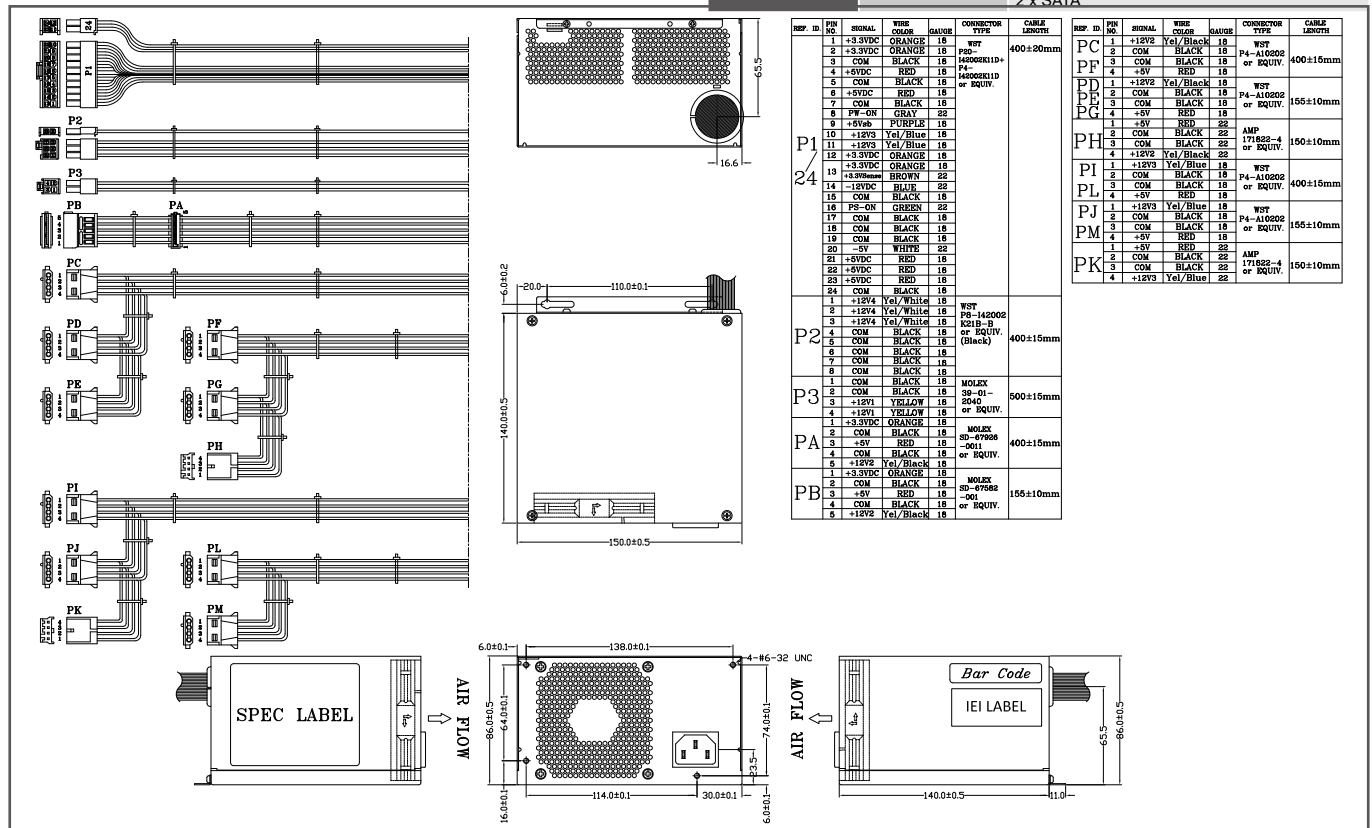



# ACE-4840APM

400 W PS/2 Medical Type ATX Power Supply



**Medical**



New Version 20+4 Pins Power Supply



## Features

1. Internal 8 cm fan
2. Meets medical safety standards
3. Line input fuse protection
4. Output overvoltage protection
5. Short circuit protection on all outputs
6. Total +12 V output up to 34 A

PICMG 1.0 Form Factor Backplane



20+4-pin ATX power connector

PICMG 1.3 Form Factor Backplane PE-10S/6S



## Specifications

Input Voltage	90 ~ 265 VAC Full Range			
Input Frequency	47 Hz ~ 63 Hz			
Input Current	8 A (RMS) for 115 VAC, 4 A (RMS) for 230 VAC			
Inrush Current	60 A max. for 115 VAC, 100 A max. for 230 VAC			
Output Voltage	<b>Voltage</b>	<b>Min. load</b>	<b>Max. load</b>	<b>Ripple &amp; Noise</b>
	+3.3 V	0.5 A min	30 A	50 mV
	+5 V	0.3 A min	30 A	50 mV
	+12 V1	1 A min	17 A	120 mV
	+12 V2	1 A min	17 A	120 mV
	-5 V		0.3 A	100 mV
	-12 V		0.8 A	120 mV
	+5 V sb		2 A	50 mV
	+3.3 V & +5 V total output not exceed 180 W +3.3 V & +5 V & +12 V total output not exceed 380 W			
Overvoltage Protection	+5 V +3.3 V +12 V	5.7 V ~ 6.5 V 3.7 V ~ 4.5 V 13.3 V ~ 15.6 V		
Hold Up Time	20 ms min.			
MTBF	100,000 hours			
Operating Temperature	0°C ~ 50°C			
Storage Temperature	-20°C ~ 80°C			
Efficiency	68%			
Dimensions (mm)	140 x 150 x 86			
Output Connector	1 x 20+4-pin ATX, 1 x 4-pin 12V CPU, 5 x HDD/CDROM, 2 x FDD, 2 x SATA, 1 x Extra +5V (P10)			

## Ordering Information

Part No.	Description
ACE-4840APM-RS	400 W AC-DC PS/2 ATX Power Supply, meets medical standard, with PFC

### Power Connector +12 V

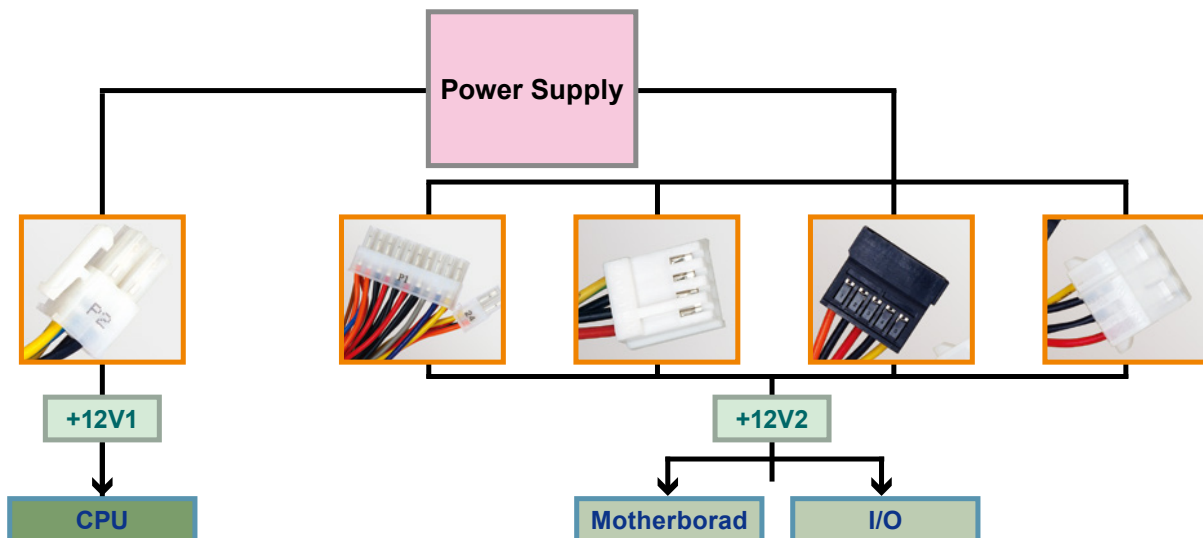

# ACE-A140B

400 W PS/2 ATX Power Supply with ErP

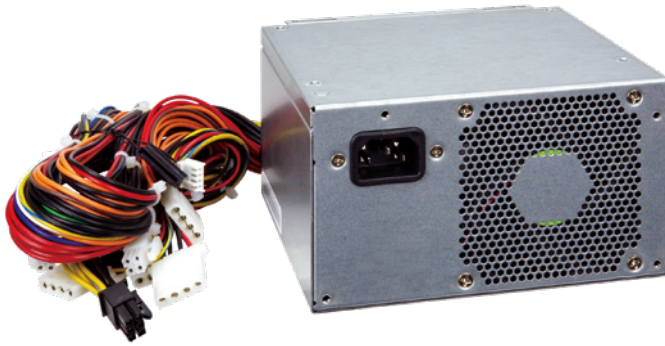

## Ordering Information

Part No.	Description
ACE-A140B-R10	400W AC-DC PS/2 ATX Power Supply with ErP, meets 80 PLUS (Bronze)

## Specifications

Input	Voltage	90~264 VAC Full Range		
	Frequency	47 Hz ~ 63 Hz		
	Input Current	5A (RMS)@115VAC, 2.5A (RMS)@230VAC		
	Inrush Current	80A max. for 115VAC 160A max. for 230VAC		
Output	Voltage	Min. load	Max. load	Ripple & Noise
	+3.3V	0 A	21 A	50mV
	+5V	0.2 A	16 A	50mV
	+12V1	0.05A	17 A	120mV
	+12V2	0 A	17 A	120mV
	-12V	0 A	0.5 A	120mV
	-5V	0 A	0.1 A	100mV
	+5VSB	0 A	3 A	50mV
The +3.3V and +5V total output shall not exceed 103W.				
Total output for this power supply is 400 watts.				
Over Voltage Protection	+3.3V:	3.76V-4.3V		
	+5V:	5.74V-7.0V		
	+12V1 and +12V2:	13.4V-15.6V		
Short Circuit Protection	+3.3V, +5V, +12V or -12V shutdown and latch off			
	Watt			
General Specifications	400W			
	PFC			
	Active			
	Hold-up Time			
	16 ms min.			
	Efficiency			
	87%			
	MTBF			
	100000 hours			
	Temperature			
Operating: 0°C ~ 50°C Storage: -20°C ~ 80°C				
Dimensions (mm)				
140 x 150 x 86				
Output Connector				
1 x 20+4-PIN ATX, 1 x 4-pin 12V CPU, 8 x HDD/CDROM, 1 x Graphics card power, 2 x FDD, 2 x SATA				

## Dimensions (Unit: mm)

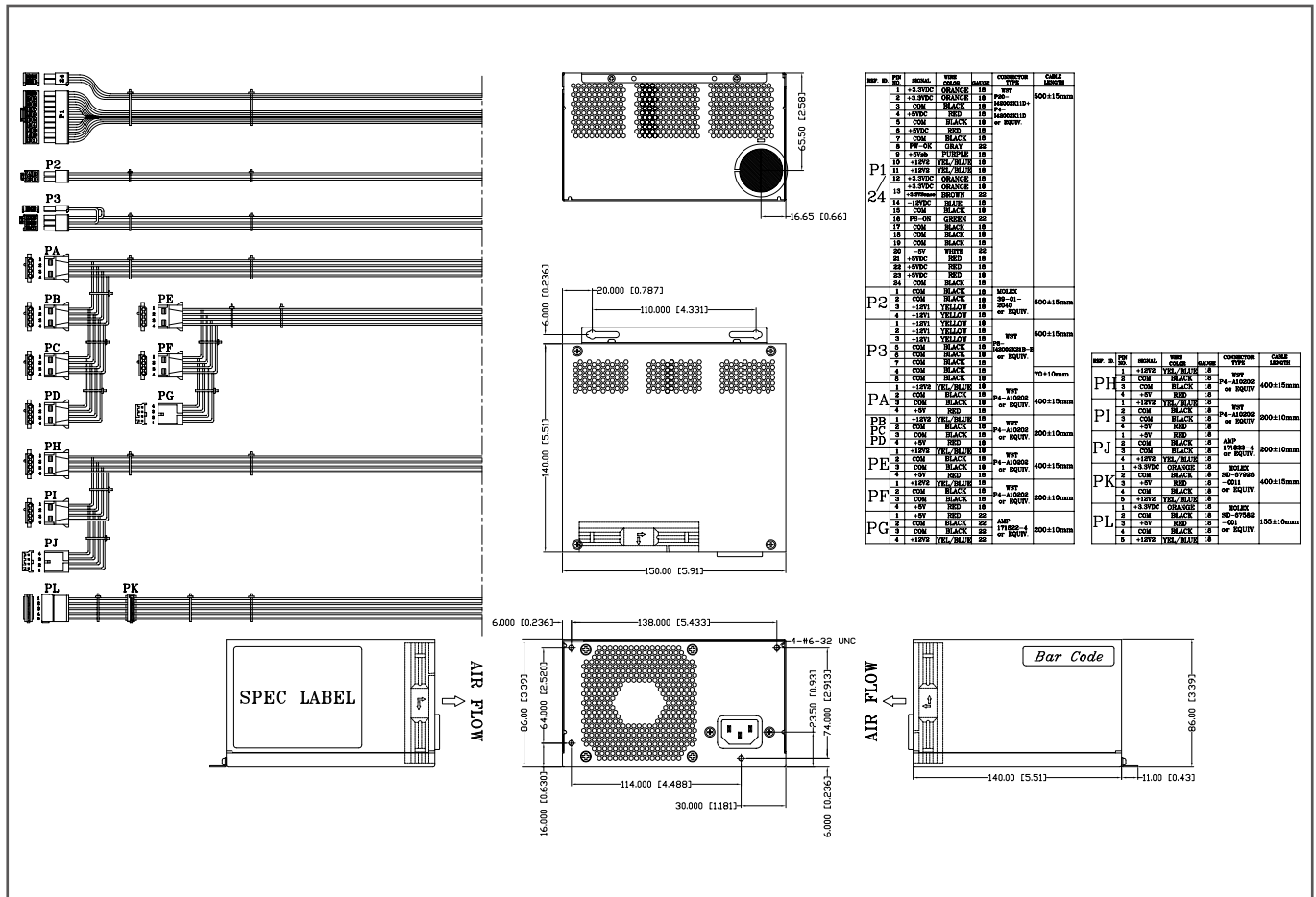

# ACE-A140B-S

400 W PS/2 ATX Power Supply with ErP

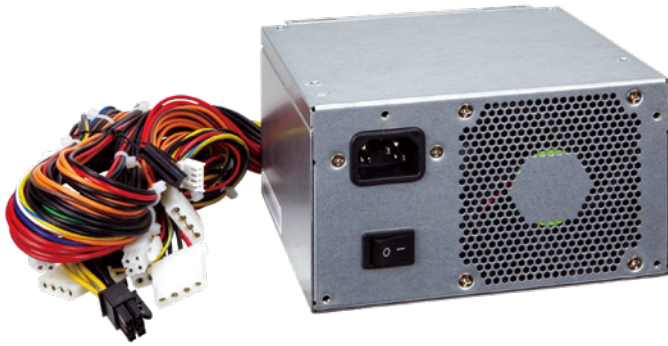

## Ordering Information

Part No.	Description
ACE-A140B-S-R10	400W PS/2 ATX Power Supply with ERP & on/off switch, meets 80 plus(Gold), RoHS

## Specifications

Input	Voltage	90~264 VAC Full Range		
	Frequency	47 Hz ~ 63 Hz		
	Input Current	5A (RMS)@115VAC, 2.5A (RMS)@230VAC		
	Inrush Current	80A max. for 115VAC 160A max. for 230VAC		
Output	Voltage	Min. load	Max. load	Ripple & Noise
	+3.3V	0 A	21 A	50mV
	+5V	0.2 A	16 A	50mV
	+12V1	0.05 A	16 A	120mV
	+12V2	0 A	17 A	120mV
	-12V	0 A	17 A	120mV
	-5V	0 A	0.1 A	100mV
+5VSB	0 A	3 A	50mV	
The +3.3V and +5V total output shall not exceed 103W				
Total output for this power supply is 400 watts.				
Over Voltage Protection	+3.3V:	3.76V-4.3V		
	+5V:	5.74V-7.0V		
	+12V1 and +12V2:	13.4V-15.6V		
Short Circuit Protection	+3.3V, +5V, +12V or -12V shutdown and latch off			
	Watt			
General Specifications	400W			
	PFC			
	Active			
	Hold-up Time			
	16ms min.			
	Efficiency			
	87%			
	MTBF			
	100000 hours			
	Temperature			
Operating: 0°C ~ 50°C Storage: -20°C ~ 80°C				
Dimensions (mm)	140 x 150 x 86			
	Output Connector	1 x 20+4-PIN ATX, 1 x 4-pin 12V CPU, 8 x HDD/CDROM, 1 x Graphics card power, 2 x FDD, 2 x SATA		

## Dimensions (Unit: mm)

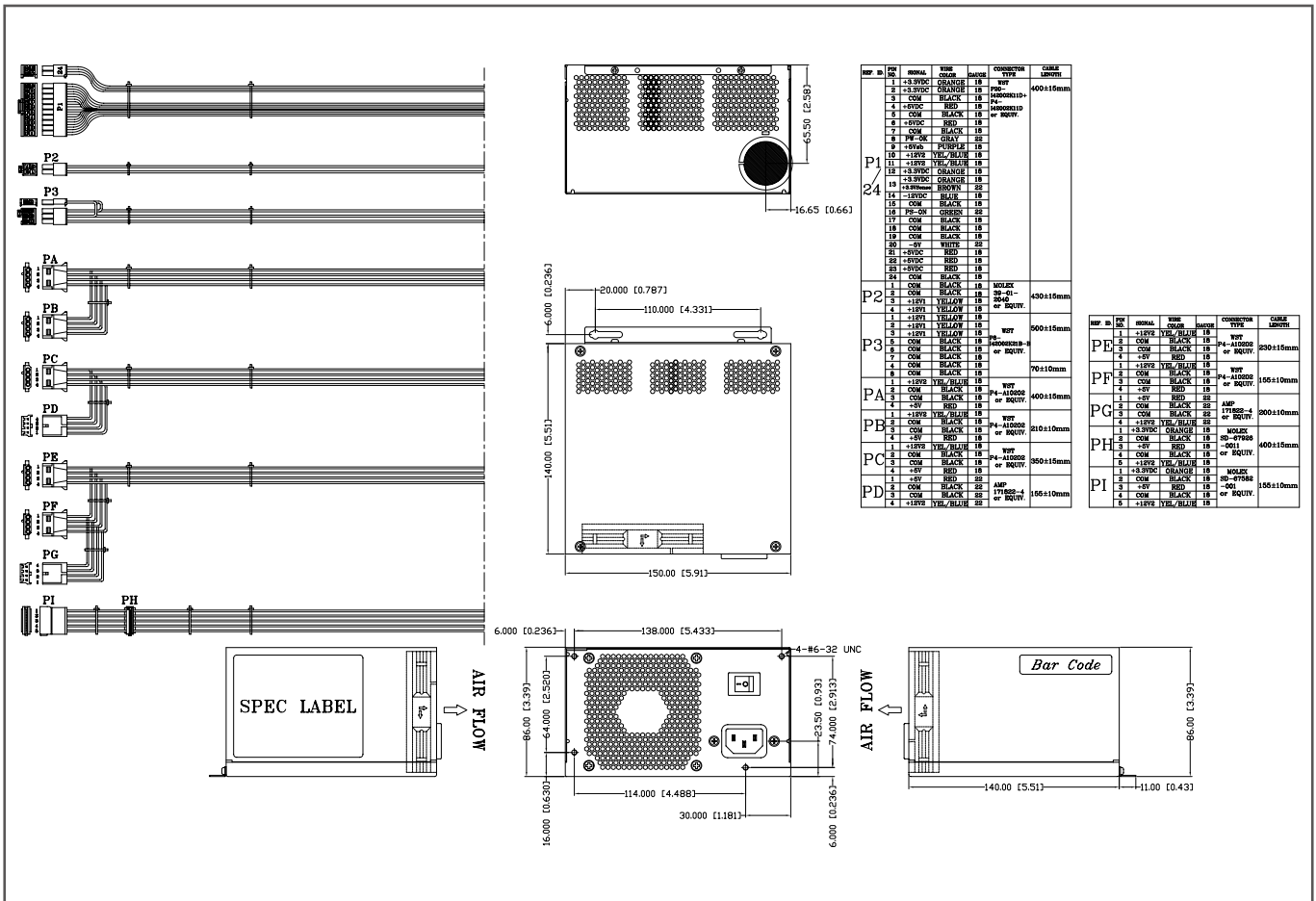

# ACE-A130C

300 W PS/2 ATX Power Supply with ErP

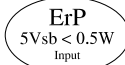
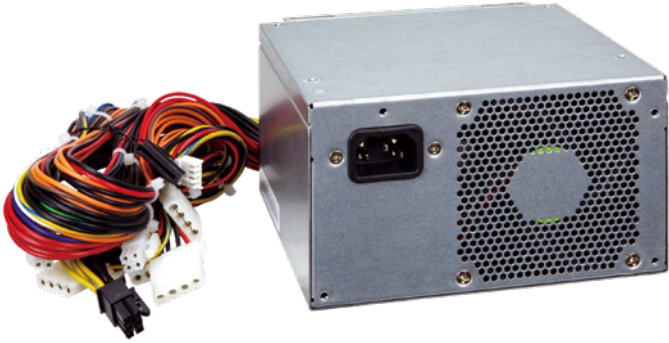

## Specifications

Input	Voltage	90~264 VAC Full Range		
	Frequency	47 Hz ~ 63 Hz		
	Input Current	4A (RMS)@115VAC, 2A (RMS)@230VAC		
	Inrush Current	80A max. for 115VAC, 160A max. for 230VAC		
Output	Voltage	Min. load	Max. load	Ripple & Noise
	+3.3V	0 A	19 A	50mV
	+5V	0.2 A	16 A	50mV
	+12V1	0.05 A	17 A	120mV
	+12V2	0 A	17 A	120mV
	-12V	0 A	0.5A	120mV
	+5VSB	0 A	3 A	50mV
	-5V	0 A	0.1 A	100mV
	Total combined output of +3.3V and +5V is ≤103W			
Total output for this power supply is 300 watts				
Over Voltage Protection	+3.3V: 3.76V-4.3V			
	+5V: 5.74V-7.0V			
Short Circuit Protection	+3.3V, +5V, +12V shutdown and latch off			
General Specifications	Watt	300W		
	PFC	Active		
	Hold-up Time	16 ms min.		
	Efficiency	87%		
	MTBF	100,000 hours		
	Temperature	Operating: 0°C ~ 50°C Storage: -40°C ~ 70°C		
	Dimensions (mm)	140 x 150 x 86		
	Output Connrctor	1 x 20+4-PIN ATX, 1 x 4-pin 12V CPU, 7 x HDD/CDROM, 1 x Graphics card power, 1 x FDD, 2 x SATA		

## Ordering Information

Part No.	Description
ACE-A130C-R10	300W PS/2 ATX Power Supply with ERP&PFC, meets 80 plus (Gold), RoHS

## Dimensions (Unit: mm)

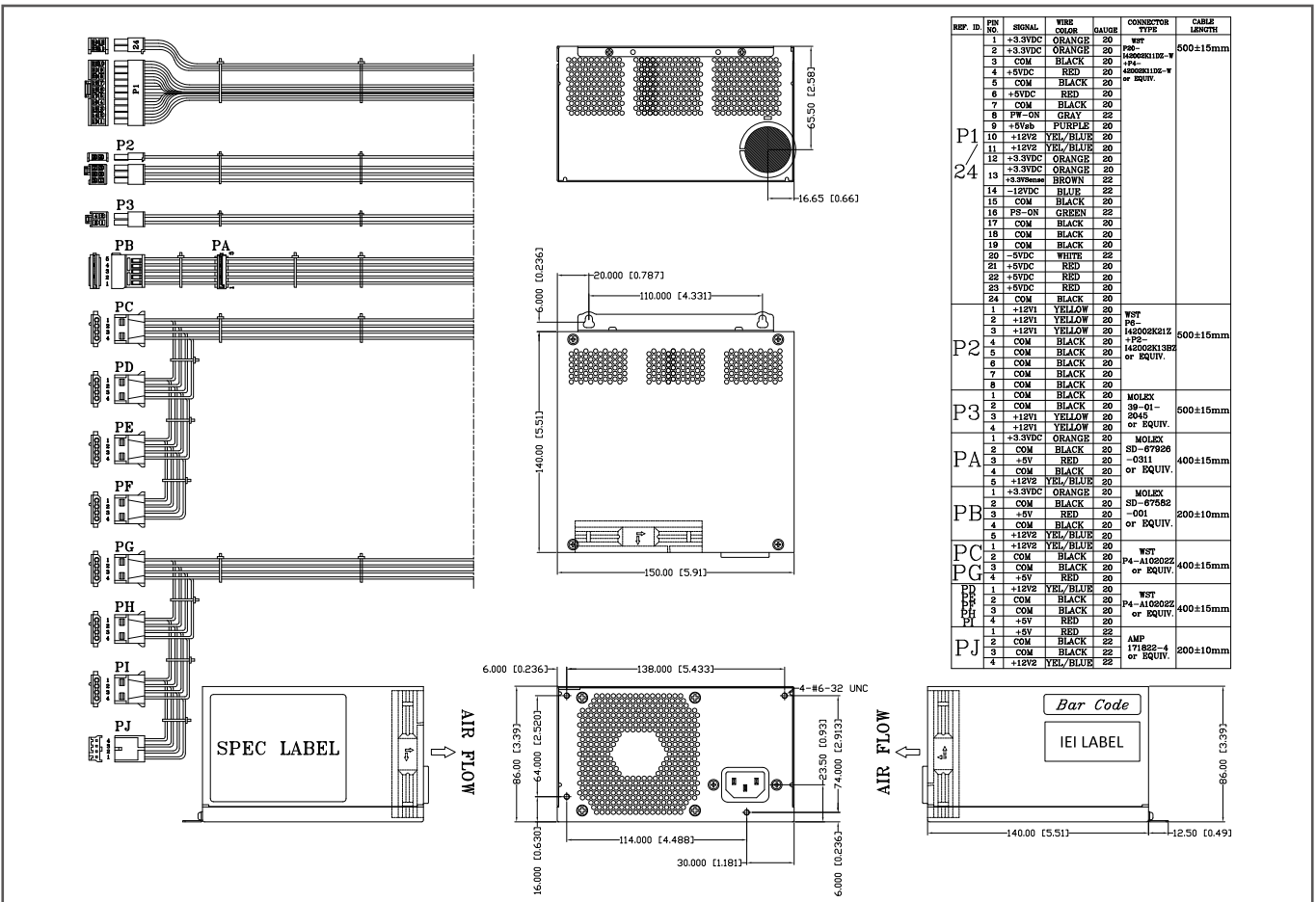



# ACE-A130C-S

300 W PS/2 ATX Power Supply with ErP

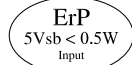

## Specifications

Input	Voltage	90~264 VAC Full Range		
Frequency	47 Hz ~ 63 Hz			
Input Current	4A (RMS)@115VAC, 2A (RMS)@230VAC			
Inrush Current	80A max. for 115VAC, 160A max. for 230VAC			
Output	Voltage	Min. load	Max. load	Ripple & Noise
	+3.3V	0 A	19 A	50mV
	+5V	0.2 A	16 A	50mV
	+12V1	0.05 A	17 A	120mV
	+12V2	0 A	17 A	120mV
	-12V	0 A	0.5A	120mV
	+5VSB	0 A	3 A	50mV
	-5V	0 A	0.1 A	100mV
Total combined output of +3.3V and +5V is ≤103W				
Total output for this power supply is 300 watts				
Over Voltage Protection	+3.3V:	3.76V-4.3V		
	+5V:	5.74V-7.0V		
Short Circuit Protection	+12V1 and +12V2:	13.4V-15.6V		
	+3.3V, +5V, +12V	shutdown and latch off		
General Specifications	Watt	300W		
	PFC	Active		
	Hold-up Time	16 ms min.		
	Efficiency	87%		
	MTBF	100,000 hours		
	Temperature	Operating: 0°C ~ 50°C Storage: -40°C ~ 70°C		
	Dimensions (mm)	140 x 150 x 86		
	Output Connrctor	1 x 20+4-PIN ATX, 1 x 4-pin 12V CPU, 7 x HDD/CDROM, 1 x Graphics card power, 1 x FDD, 2 x SATA		

## Ordering Information

Part No.	Description
ACE-A130C-S-R10	300W PS/2 ATX Power Supply with ERP/PFC & on/off switch, meets 80 plus (Gold), RoHS

## Dimensions (Unit: mm)

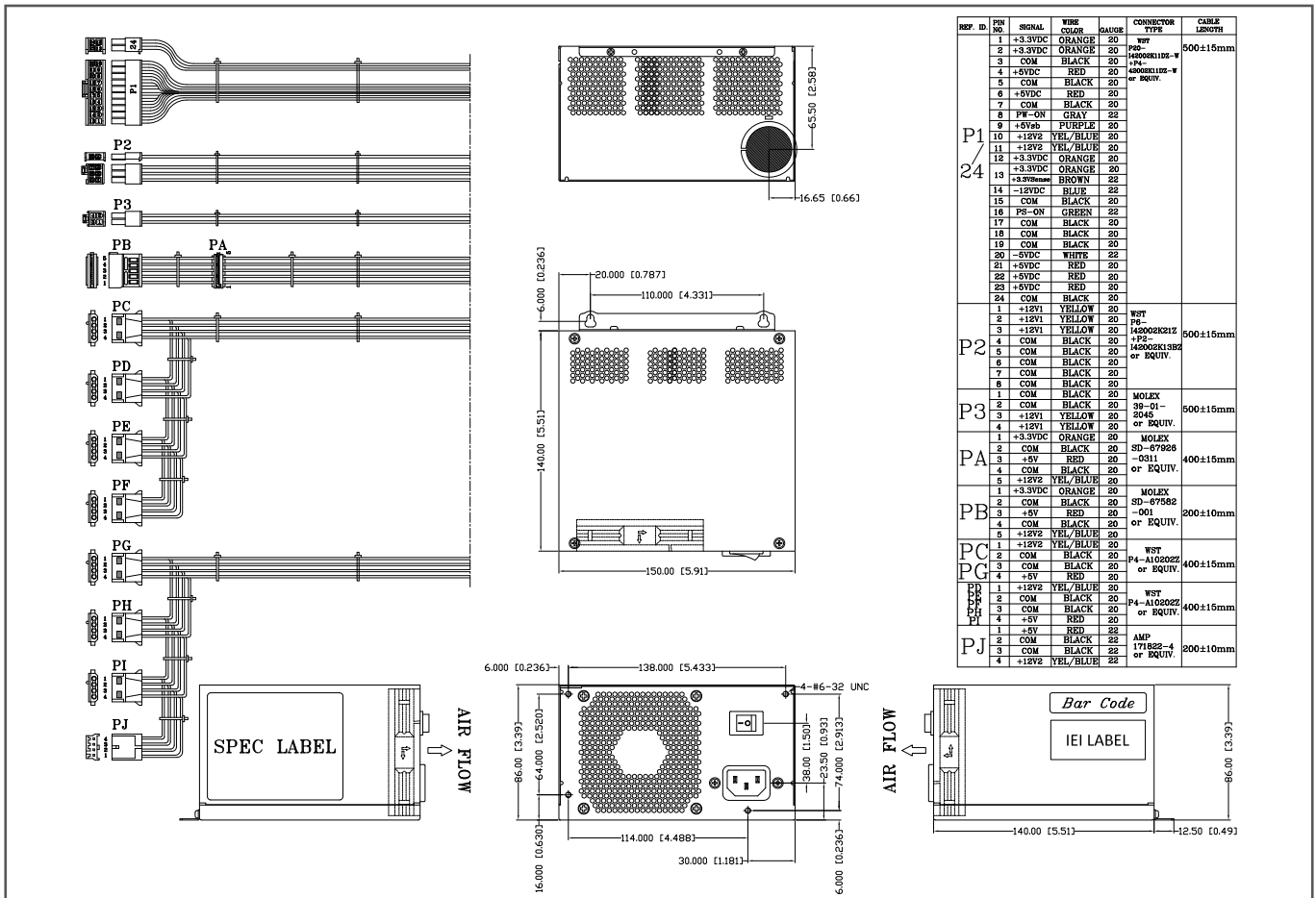



# Optional Power Supply Cables

## ■ AC Input Solution

20 cm AC input cable with I/O connector and fuse

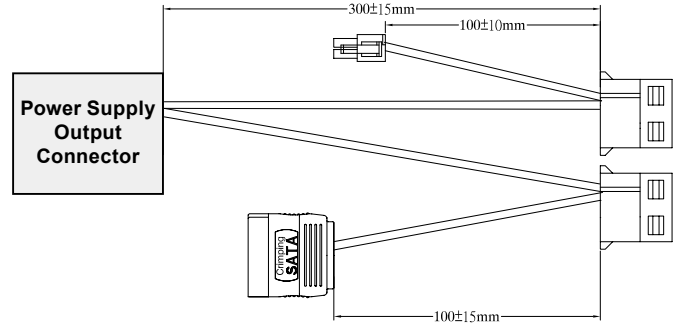

## ■ Embedded Solution

30 cm cable with SATA, 12 V and IDE device connectors

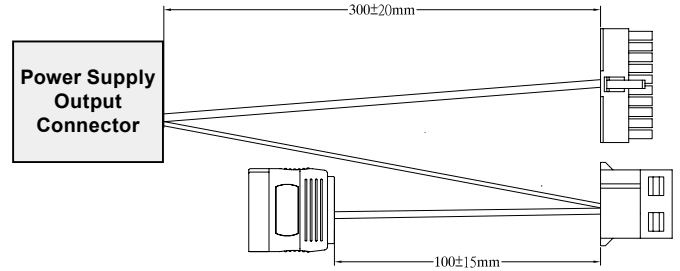

## ■ ATX Backplane Solution

30 cm cable with IDE, ATX and SATA device connectors

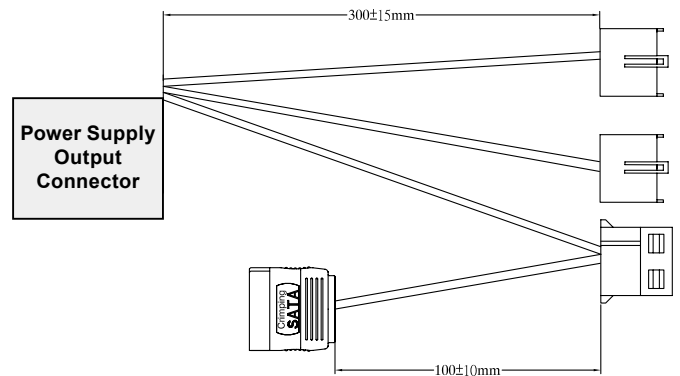
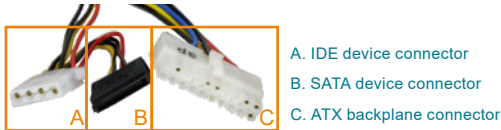

## ■ AT P8P9 Backplane Solution

30 cm cable with SATA, IDE and P8P9 AT device connectors

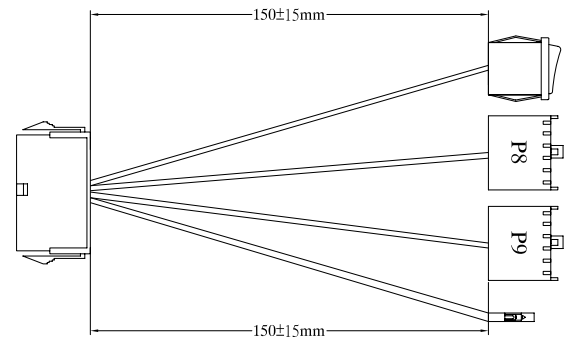

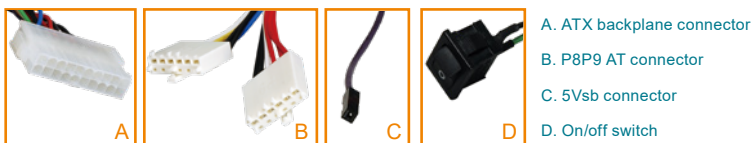

## ■ AT Backplane with ATX Power Supply Solution

15 cm cable with ATX, P8P9 and 5VSB connectors, and on/off switch



# Redundant Type Selection Guide

## AC Input

Product	Model No.	Watt AT/ATX PFC	Input Range Voltage	Output Current Range						Efficiency	Operating Temperature	Safety	Dimensions (mm)
				+3.3 V	+5 V	+12 V	-5 V	-12 V	+5 Vsb				
	ACE-R4150AP	500W ATX PFC	90 ~ 264 VAC	20A (0A min.)	20A (0A min.)	40A (1A min.)	0.3 A (0A min.)	0.5 A (0A min.)	3 A	84%	0°C ~ 50°C	CB, UL, TUV, CCC, CE, FCC	150 × 84 × 190
	ACE-R4130AP	300W ATX PFC	90 ~ 264 VAC	18 A (1 A min.)	25 A (3 A min.)	16 A (2 A min.)	0.5A	0.5 A	2 A (0.1 A min.)	65%	0°C ~ 50°C	CB, UL, TUV, CCC, CE, FCC	150 × 84 × 190

## ACE-R4150AP

500 W ATX Mini Redundant Power Supply



**New**



### Specifications

Input	Voltage	90 ~ 264 VAC Full Range		
	Frequency	47 Hz ~ 63 Hz		
	Input Current	6 A (RMS) @115 VAC, 3 A (RMS) @230 VAC		
	Inrush Current	40 A max. for 115 VAC, 80 A max. for 230 VAC		
Output	Voltage	Min. load	Max. load	Ripple & Noise
	+3.3 V	0 A	20.0 A	50mVp-p
	+5 V	0 A	20.0 A	50mVp-p
	+12V	1 A	40.0 A	1200mVp-p
	-5 V	0 A	0.3 A	200mVp-p
	-12 V	0 A	0.5 A	200mVp-p
+5 VSB	0 A	3 A	50mVp-p	
General Specifications	Watt	500 W		
	Hold-up Time	The power supply holdup time requirements to 100% of maximum load.		
	Efficiency	84% min		
	MTBF	100,000 hours		
	Temperature	Operating: 0°C ~ 50°C, Storage: -20°C ~ 80°C		
	Dimensions	150 × 84 × 190 (mm)		
Output Connector	1 x 24-pin ATX, 2 x 4+4-pin 12V CPU, 2 x HDD/CDROM, 1 x FDD, 2 x SATA, 1 x T.T.L signal, 1 x LED power			

### Dimensions (Unit: mm)

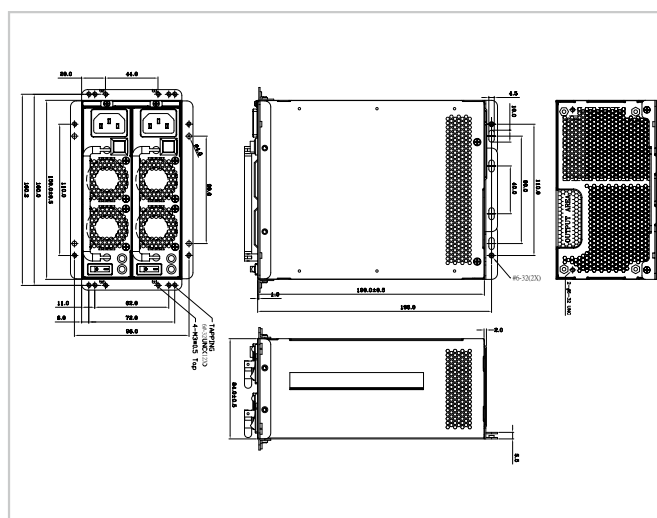

### Ordering Information

Part No.	Description
ACE-A4150AP-R10	500W ATX Redundant Power Supply, includes two ACE-R4150AP1-RS, with PFC function; CCL
ACE-A4150AP1-R10	500W AC-DC ATX Redundant module, for ACE-R4150AP, with PFC, CCL; RoHS



# Adapter Type Selection Guide

- **Safety (ITE Standard)** - CB IEC 62368, UL 62368, CSA C 22.2 No. 62368 ,TUV EN 62368
- **Safety (Medical Standard)** - CB IEC 60601, UL 60601, CSA C 22.2 No. 60601, TUV EN 60601
- **EMI** - Meets EN 55032, FCC Part 15, CISPR 32 Meets EN 61000-3-2, EN 61000-3-3 (PFC function)
- **EMS** - Meets EN 55024, EN 61000-4-2/3/4/5/6/8/11

\* For detailed specs, please refer to official certification

AC Input											
Product	Model No.	Watt	Input Range	Output Current Range			Plug Type	Efficiency	Operating Temperature	Safety	Dimensions (mm)
			Voltage	+5V	+12 V	+19 V					
	<b>New</b> FSP150-ABAN3	150W	90~264 VAC		10 A	7.89A		87%	0°C ~ 40°C	UL/TUV CCC/CE/ GS/PSE/KC/ BSMI	75.6 x 151.3 x 25.4
	FSP120-AHAN3	120W	90~264 VAC		10 A			87%	0°C ~ 40°C	UL/TUV CCC/CE/ GS/PSE/KC/ BSMI	75.6 x 151.3 x 25.4
	FSP096-AHAN3	96W	90~264 VAC		8 A			88%	0°C ~ 40°C	UL/TUV/CCC/ CE/GS/PSE/ KC/BSMI/ RCM	75.6 x 151.3 x 25.4
	FSP090-DBBN3	90W	90~264 VAC			4.74 A		88%	0°C ~ 40°C	UL/TUV/CCC/ CE/GS/PSE/ KC/BSMI/ RCM/PSE	51 x 129 x 30.9
	FSP065-RBBN3	65W	90~264 VAC			3.42 A		89.54%	0°C ~ 40°C	UL/TUV/CCC/ CE/BSMI/ PSE/PSB/GS/ EAC/NOM/ RCM/IRAM/ Nrcan/Nemko	46.3 x 108.3 x 30
	FSP060-DHAN3	60W	90 ~ 264 VAC		5V			85%	0°C ~ 40°C	UL/TUV/CCC/ GS/PSE/RCM/ CE/KC /BSMI	62 x 110 x 31.5
	FSP036-RHBN3	36W	90 ~ 264 VAC		3 A			88.3%	0°C ~ 40°C	UL/TUV/CCC/ GS/CE/BSMI/ PSE/RCM/KC	37.8 x 89.8 x 27

# FSP150-ABAN3

150 W AC/DC Adapter



**New**



Plug Type: Power mini-DIN (4P)



**\*\*Meet ErP & PSE**

## Specifications

- Input Voltage Range: 90-264 VAC
- Input Frequency: 47-63 Hz
- Output Voltage: 19 V
- Output Current: 7.89 A
- Output Watts: 150 W
- Efficiency: 87%
- Operating Temperature: 0°C ~ 40°C
- Storage Temperature: -20°C ~ 80°C

## Dimensions (Unit: mm)

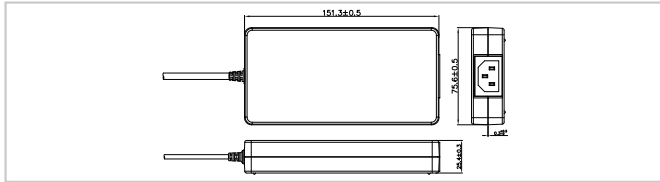

## Ordering Information

Part No.	Description
63040-010150-700-RS	19 V 150W power adapter, 90~264 VAC input, ErP, PSE

# FSP120-AHAN3

120 W AC/DC Adapter



Plug Type: Power mini-DIN (4P)



**\*\*Meet ErP & PSE**

## Specifications

- Input Voltage Range: 90-264 VAC
- Input Frequency: 47-63 Hz
- Output Voltage: 12 V
- Output Current: 10 A
- Output Watts: 120 W
- Efficiency: 87%
- Operating Temperature: 0°C ~ 40°C
- Storage Temperature: -20°C ~ 80°C

## Dimensions (Unit: mm)

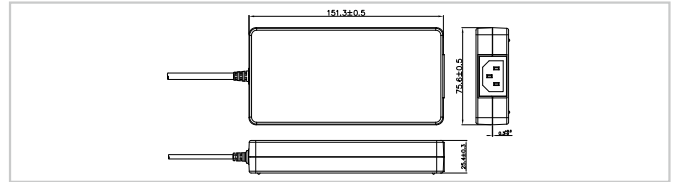

## Ordering Information

Part No.	Description
63040-010120-300-RS	12 V 120W power adapter, 90~264 VAC input, ErP, PSE

# FSP096-AHAN3

96 W AC/DC Adapter



Plug Type: Power mini-DIN (4P)



**\*\*Meet ErP & PSE**

## Specifications

- Input Voltage Range: 90-264 VAC
- Input Frequency: 47-63 Hz
- Output Voltage: 12 V
- Output Current: 8 A
- Output Watts: 96 W
- Efficiency: 88%
- Operating Temperature: 0°C ~ 40°C
- Storage Temperature: -20°C ~ 80°C

## Dimensions (Unit: mm)

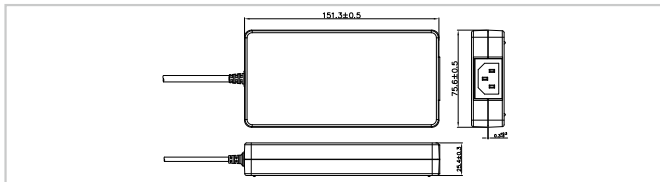

## Ordering Information

Part No.	Description
63040-010096-200-RS	12 V 96W power adapter with DIN 4-pin/lock 90~264 VAC input, ErP, PSE, KC, BSMI

# FSP090-DBBN3

87 W AC/DC Adapter



Plug Type: Power mini-DIN (4P)

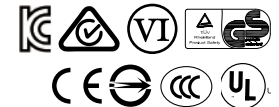

**\*\*Meet ErP & PSE**

## Specifications

- Input Voltage Range: 90-264 VAC
- Input Frequency: 47-63 Hz
- Output Voltage: 19 V
- Output Current: 4.74 A
- Output Watts: 90 W
- Efficiency: 88%
- Operating Temperature: 0°C ~ 40°C
- Storage Temperature: -20°C ~ 80°C

## Dimensions (Unit: mm)

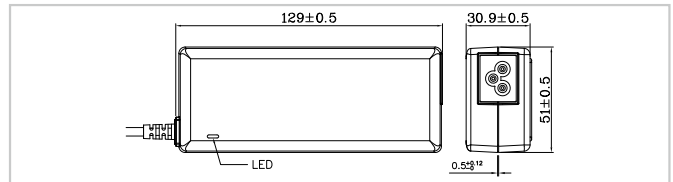

## Ordering Information

Part No.	Description
待提供	19 V 90W power adapter with DIN 4-pin/lock 90~264 VAC input, ErP



# FSP065-RBBN3

65 W AC/DC Adapter



Plug Type:  $\phi$ in 2.1 mm /  $\phi$ out 5.5 mm

\*\*Meet ErP & PSE



## Ordering Information

Part No.	Description
63040-010065-710-RS	19 V 65W power adapter with $\Phi$ 2.1/ $\Phi$ 5.5/lock 90~264 VAC input, ErP, PSE

## Specifications

- Input Voltage Range: 90-264 VAC
- Input Frequency: 47-63 Hz
- Output Voltage: 19 V
- Output Current: 3.42 A
- Output Watts: 65 W
- Efficiency: 86%
- Operating Temperature: 0°C ~ 40°C
- Storage Temperature: -20°C ~ 80°C

## Dimensions (Unit: mm)

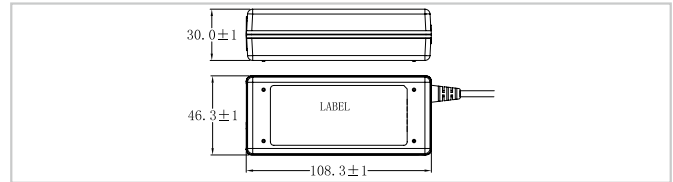

# FSP060-DHAN3

60 W AC/DC Adapter

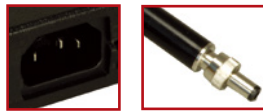

Plug Type:  $\phi$ in 2.5 mm /  $\phi$ out 5.5 mm

\*\*Meet ErP & PSE



## Ordering Information

Part No.	Description
63040-010060-211-RS	12 V 60W power adapter with lock screw 90~264 VAC input, ErP, PSE
63040-010060-200-RS	12 V 60W power adapter with none lock 90~264 VAC input, ErP, PSE

## Specifications

- Input Voltage Range: 90-264 VAC
- Input Frequency: 47-63 Hz
- Output Voltage: 12 V
- Output Current: 5 A
- Output Watts: 60 W
- Efficiency: 85%
- Operating Temperature: 0°C ~ 40°C
- Storage Temperature: -20°C ~ 65°C

## Dimensions (Unit: mm)



# FSP036-RHBN3

36 W AC/DC Adapter

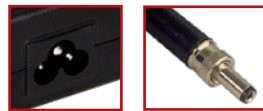

Plug Type:  $\phi$ in 2.5 mm /  $\phi$ out 5.5 mm

\*\*Meet ErP & PSE



## Ordering Information

Part No.	Description
63040-010036-210-RS	12 V 36W Power adapter with lock screw, 90~264VAC input, ErP, PSE
63040-010036-220-RS	12 V 36W Power adapter without lock, 90~264VAC input, ErP, PSE

## Specifications

- Input Voltage Range: 90-264 VAC
- Input Frequency: 47-63 Hz
- Output Voltage: 12 V
- Output Current: 3 A
- Output Watts: 36 W
- Efficiency: 88.3%
- Operating Temperature: 0°C ~ 40°C
- Storage Temperature: -20°C ~ 80°C

## Dimensions (Unit: mm)

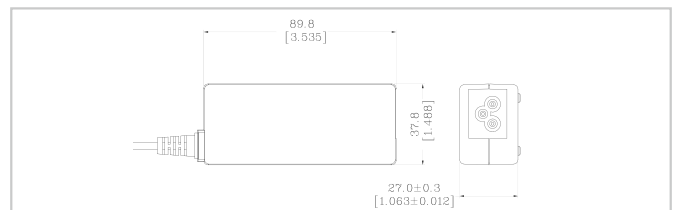

# How to Configure the IDD & PM\_P Series

## AT Mode

1. Power supply without any control signal
2. Power is controlled directly by the power supply's on/off switch.

### Installation

**Step 1.** Set the jumper on the power modules and SBC to AT mode (if available)

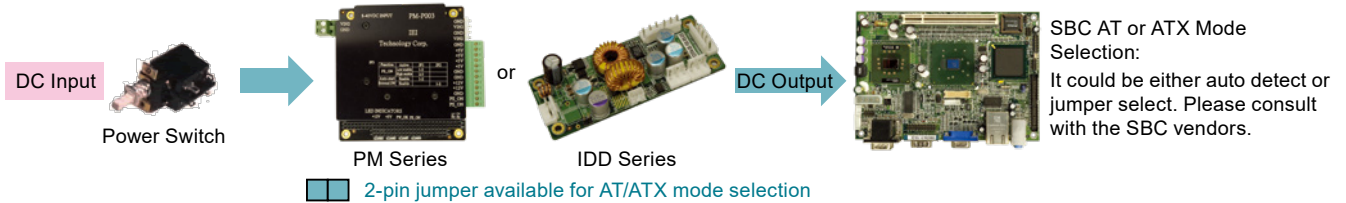

**Step 2.** Connect all input and output power cables **Step 3.** Wire/Isolate DC input by power switch **Step 4.** Power up by switch

## ATX Mode (supports normal Windows® OS power down)

1. Required 5VSB (5V standby power) to SBC.
2. Power supply on/off control by "PS\_On#" signal.
3. PS\_On# is an active low signal that turns on all power rails.

### Installation

**Step 1.** Set the jumper on the power modules and SBC to ATX mode (if available)

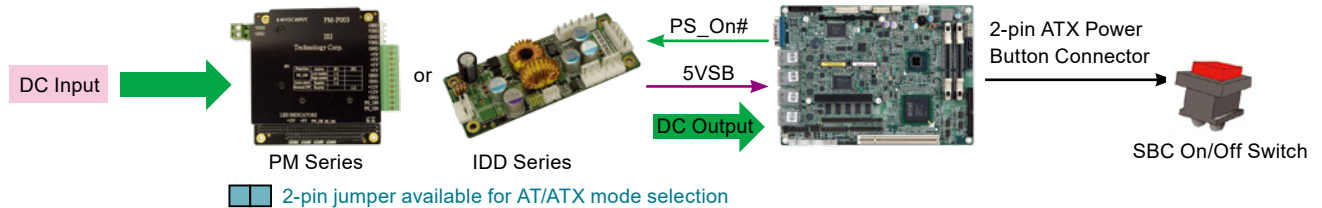

**Step 2.** Wire 5VSB and PS\_ON# from power module to SBC **Step 3.** Wire all input, output power cables **Step 4.** Power up system by SBC on/off switch

## Simulated AT Mode

1. The 5 V standby power is not provided to the SBC.
2. Power supply power is controlled by the "PS\_On#" signal.
3. The power switch is connected to the power supply.

### Installation

**Step 1.** Set the jumper on the power modules to ATX mode and set the jumper on the SBC to AT mode (if available)

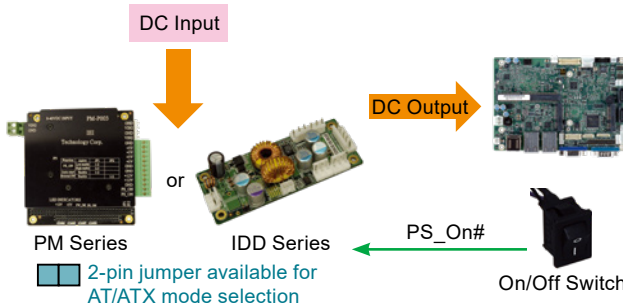

**Step 2.** Connect 5VSB & PS\_ON# from the power module to the SBC.  
**Step 3.** Connect all input and output power cables.  
**Step 4.** Power up the system using the power switch connected to the SBC.

## From Scratch to Sustain - Commitment

A partnership with IEI does not end at product shipment. We're beside you with ongoing product support as your products evolve and change to meet emerging market requirements.

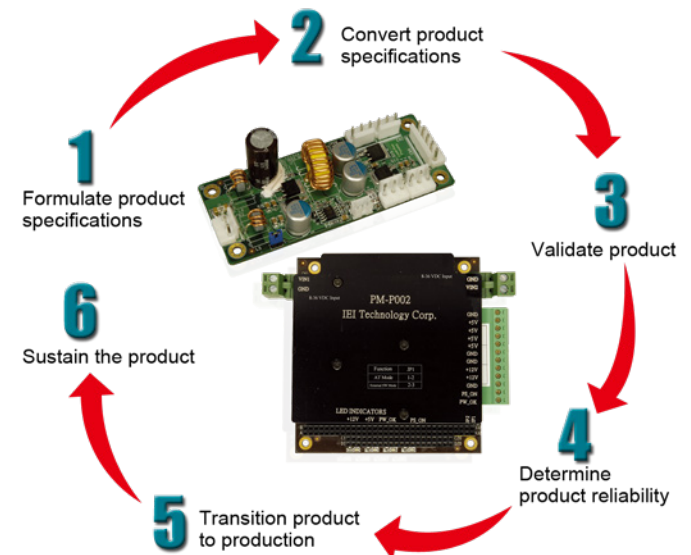

# Product List

Model No.	Dimensions	Maximum Output Power	Input Voltage	Maximum Output Current						
				12V	5V	3.3V	-12V	5VSB	16V	20V
IDD-936160	25 mm x 82 mm	60 W	9 ~ 36 V	5 A	-	-	-	-	-	-

## Naming Conventions:

IDD xx - 630 4 120 A

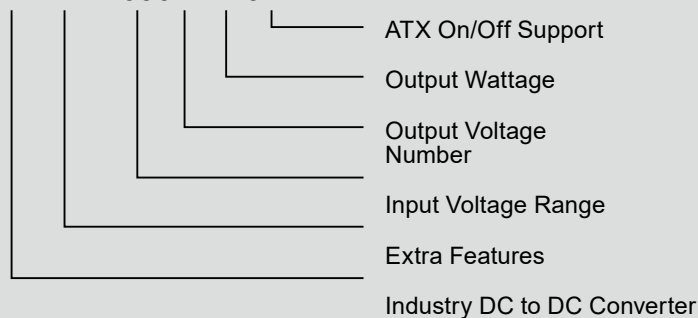

## Dedicated Engineering Team - Professional

Our dedicated team offers application-specific integrated solutions and will design a customized product that will put you in front of the competition. Our solutions include standard/non-standard voltages, isolated/non-isolated, any form factor, power sequencing, battery chargers, electromechanical interference protection, thermal management, remote on/off and I/O interface.



## Advanced Test Equipment – Precision & Reliability



Timing/Noise Analyzer Chroma 6011



Electronic Load Chroma 6312 Series



Power Analyzer Chroma 6632

# IDD-936160

60 W DC/DC Converter Module



IDD-936160 60W DC/DC Converter Module is a high performance buck-boost switching regulator power module. The constant frequency current mode architecture allows a phaselockable frequency of up to 400 kHz. With a wide 9V to 36V input and 12V output and seamless transfers between operating modes, the IDD-936160 is ideal for embedded systems with limited space.

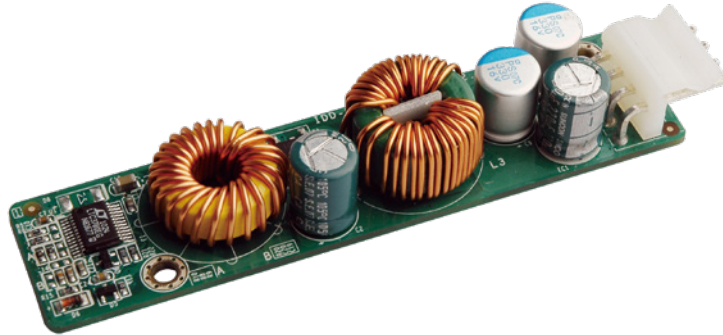

## Specifications

- Output (max.): 12 V@5 A
- Max. total output: 60 W
- Input: 9 VDC to 36 VDC
- Performance characteristics  
 Noise & ripple: <300 mV  
 Line regulation: <300 mV  
 Load regulation: <85 mV  
 Efficiency up to 95%
- Dimensions (mm): 82 x 25
- Weight (NW): 28 g
- Operating temperature: -40°C ~ 85°C

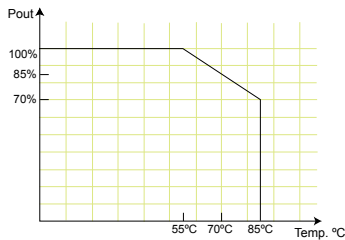

## Features

1. Wide input range: 9-36 VDC
2. 12 VDC output up to 5 Amp
3. Compact size
4. Efficiency up to 95%
5. RoHS compliant

## Dimensions (Unit: mm)

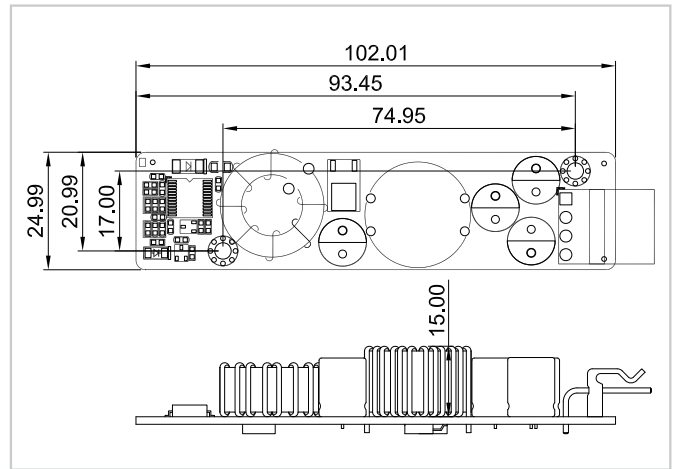

## Pin Assignments

Input/Output Connector

VOUT1	Pin1	Pin2	Pin3
	+12 V Output	GND	Vin



Cable

P/N: 32102-015700-100-RS

## Packing Information

1 x IDD-936160	1 x QIG
1 x 300 mm wire cable (P/N: 32102-015700-100-RS)	





## Ordering Information





Part No.	Description
IDD-936160-R20	60 W DC/DC 9~36 V input, 12 V output

## CPU Cooler *High performance thermal solutions*

Choosing the wrong CPU cooler for a system can lead to serious overheating, resulting in system shutdown and potential damage to CPUs.

For industrial applications, the following CPU coolers fit the needs of various operating environments, where different levels of cooling are required.

IEI Special Desktop Core™ CPU Cooler				
				
Where Used	For spacial models: SPCIE-C2260, PCIE-Q870, PCIE-H810, WSB-H810, KINO-AQ870			
Model Name	CF-1150SA-R10	CF-1150SB-R11	CF-1150SC-R20	CF-1150SE-R11
Description	IEI customized cooler for LGA1150 Intel® CPU, RoHS		IEI customized cooler for LGA1150 Intel® CPU, 1U chassis compatible, RoHS	IEI customized cooler for LGA1150 Intel® CPU, RoHS
CPU Solution	Intel® Core™ i7/i5	Intel® Core™ i7/i5	Intel® Core™ i7/i5	Intel® Core™ i7/i5
Socket Solution	LGA1150/LGA1151	LGA1150/LGA1151	LGA1150/LGA1151	LGA1150/LGA1151
Dimensions (mm)	83 x 83 x 57	96 x 82 x 60	105 x 80 x 23.7	107 x 70 x 60
Material	Al	Al	Cu	Cu
Bearing Type	Ball And sleeve	Two-ball	Two-ball	Two-ball
Capability (Watt)	<b>95 W</b>	<b>65 W</b>	<b>65 W</b>	<b>95 W</b>
Fan Speed (RPM)	4200	3500	5500	4200
Noise Level (dBA)	40	41	55	36
Life Expectancy (hrs)	40,000	50,000	50,000	50,000
Weight	330 g	286 g	406 g	812 g



Intel® Standard Desktop Core™ CPU Cooler					
					
	LGA115X (LGA1150/LGA1151/LGA1155/LGA1156)				
Model Name	CF-115XA-R10	CF-1156C-R20	CF-1156D-R30	CF-115XE-R10	CF-115XF-R10
Description	High performance LGA1155/ LGA1156 cooler kit, 1U chassis compatible	Low power LGA1155/LGA1156 cooler Kit, RoHS		High performance LGA1155/ LGA1156 CPU cooler, RoHS	High performance LGA1155/ LGA1156 CPU cooler, RoHS
CPU Solution	Intel® Core™ i5/i3	Intel® Core™ i5/i3	Intel® Core™ i7/i5/i3	Intel® Xeon®/Core™ i7/i5/i3	Intel® Xeon®/Core™ i7/i5/i3
Socket Solution	LGA115X (LGA1150/LGA1151/LGA1155/LGA1156)				
Dimensions (mm)	89 x 92.6 x 27.4	90 x 90 x 33	90 x 90 x 33	91 x 91 x 84	90 x 90 x 69.3
Material	Cu	Al	Cu+Al	Al	Al
Bearing Type	Two-ball	Two Ball	Two Ball	Ball and Sleeve	Two Ball
Capability (Watt)	<b>73 W</b>	<b>45 W</b>	<b>65 W</b>	<b>95 W</b>	<b>95 W</b>
Fan Speed (RPM)	5500	3600	3600	4200	4200
Noise Level (dBA)	51	40	40	40	48
Life Expectancy (hrs)	50,000	70,000	70,000	40,000	50,000
Weight	422 g	198 g	240 g	301 g	432 g





## CPU Cooler *High performance thermal solutions*

Choosing the wrong CPU cooler for a system can lead to serious overheating, resulting in system shutdown and potential damage to CPUs.

For industrial applications, the following CPU coolers fit the needs of various operating environments, where different levels of cooling are required.

Desktop CPU Cooler		
		
LGA775 Cooler		
Model Name	CF-775B-RS-R11	CF-520-RS-R11
Description	High performance 1U LGA 775 CPU cooler, with 7010 fan, RoHS	High performance LGA 775 CPU cooler, RoHS
CPU Solution	Intel® Core™2 Duo	Intel® Core™2 Duo
Socket Solution	LGA 775	LGA 775
Dimensions (mm)	80.5 x 81 x 28.2	115 x 115 x 67
Material	Cu	Aluminum alloy
Bearing Type	Two-ball	Two-ball
Capability (Watt)	<b>90 W</b>	<b>115 W</b>
Fan Speed (RPM)	4250	4500
Noise Level (dBA)	40	47.5~51.5
Life Expectancy (hrs)	50,000	70,000
Weight	600 g	635 g

CPU Cooler		Mobile Core™ i7 CPU Cooler	
			
Blower		PGA989	
Model Name	BF-02-RS	CF-989A-RS-R12	CF-989B-RS-R11
Description	Bracket cooling fan, RoHS	High performance Socket-G (PGA989) smart fan CPU cooler, RoHS	High performance Socket-G (PGA989) CPU cooler, aluminum, RoHS
CPU Solution	Bracket cooling fan	Intel® Core™ i7/i5/i3	Intel® Core™ i7/i5/i3
Socket Solution		PGA989	PGA989
Dimensions (mm)	112 x 90 x 21	60 x 60 x 27.5	60 x 60 x 27.5
Material	Plastic	Cu	Al
Bearing Type	One-ball	Two-ball	Two-ball
Capability (Watt)		<b>55 W</b>	<b>50 W</b>
Fan Speed (RPM)	2800	4800	4800
Noise Level (dBA)	28	40	40
Life Expectancy (hrs)	45,000	50,000	50,000
Weight	107.5 g	255 g	26 g

## CPU Cooler *High performance thermal solutions*

Choosing the wrong CPU cooler for a system can lead to serious overheating, resulting in system shutdown and potential damage to CPUs.

For industrial applications, the following CPU coolers fit the needs of various operating environments, where different levels of cooling are required.

	CPU Cooler			
				
Model Name	19100-000316-00-RS	19100-000317-00-RS	19100-000312-00-RS	19100-000318-00-RS
SBC	IMBA-Q470	IMBA-Q470	IMBA-Q470	IMBA-Q470
	IMBA-Q471	IMBA-Q471	IMBA-Q471	IMBA-Q471
CPU Solution	Core™ i9/i7/i5/i3	Core™ i9 /i7/i5/i3	Core™ i9/i7/i5/i3	Core™ i9/i7/i5/i3
Socket Solution	LGA 115X/1200	LGA 1156	LGA115X/1200	LGA115X/1200
Dimensions(mm)	91x 90x 65.5	105 x 92.5 x 125.8	92.5 x 90 x 30.15	103x 95x 127
Material	VC+AL	CU+AL	Al	Al
Bearing Type	Two-Ball	Two-Ball	Two-Ball	Two-Ball
Capability (Watt)	<b>125W</b>	<b>125W</b>	<b>125W</b>	<b>125W</b>
Fan Speed(RPM)	8500	2800	7000	3600
Noise Level(dBA)	55	36	59	44
Life Expectancy (hrs)	70000	70000	80000	70000
Temp.	0°C-45°C	0°C-45°C	0°C-40°C	0°C-50°C
Weight	430 g	660g	435g	380g

# Industrial SATADOM Series

## ■ The world's smallest high-speed SATADOM

The revolutionary form factor of SATADOM has been widely adopted by industrial and embedded system makers across the globe. With in-house designed SATA 6Gb/s controller, the SATADOM provides you not only the fastest read/write speed but also stable data transfer. Moreover, to address customer's challenging requirements, we have released a series of the smallest SATADOM which fits various kinds of compact systems. Here, we recommend five models by different heights. For the low-profile 1U system use, you can choose SL 3SE, SH 3SE, and SH 3ME.

## ■ SATA 6Gb/s Solutions

### Powerful Performance

SATA 6Gb/s devices have 191% higher performance than SATA 3Gb/s devices.

### Less Power Consumption





The advanced idle mode helps to save up to 35% of energy when system stays in idle, therefore the battery runtime increases and the system requests less power consumption than SATA 3Gb/s.

### Greater Reliability

The in-house designed SATA 6Gb/s controller offers an excellent signal quality during data transfer, enhancing the system compatibility and stability.

### Easier Use

Along with upgrading to SATA 6Gb/s, the one-touch activation mode of iSMART 3.2 can save hours of setup and maintenance time.

Model Name	IFM-3010V	IFM-3320M	IFM-3010L	IFM-3010H	IFM-3020HM	
Picture						
Key Features	<ol style="list-style-type: none"> <li>Vertical version</li> <li>Anti-vibration mechanical design</li> </ol>	<ol style="list-style-type: none"> <li>Vertical version</li> <li>Writing protection</li> <li>Anti-vibration mechanical design</li> </ol>	<ol style="list-style-type: none"> <li>SATA 6Gb/s interface</li> <li>iSMART disk health monitoring</li> <li>Intelligent error recovery system</li> <li>Excellent data transfer speed</li> <li>Zero mechanical interference</li> <li>Anti-vibration mechanical design</li> </ol>	<ol style="list-style-type: none"> <li>Horizontal version</li> <li>Only exposes 12mm height on the motherboard after installation</li> </ol>	<ol style="list-style-type: none"> <li>Low profile horizontal design</li> <li>High IOPS</li> </ol>	
Interface	SATA 6Gb/s	SATA 6Gb/s	SATA 6Gb/s	SATA 6Gb/s	SATA 6Gb/s	
Flash Type	SLC	MLC	SLC	SLC	MLC	
Capacity (GB)	1GB~32GB	8GB~128GB	1GB~32GB	1GB~32GB	8GB~128GB	
Sequential R/W	300/130	355/135	300/130	300/130	200/75	
Max. Power Consumption	0.65W (5V x 130mA)	1W (5V x 200mA)	0.65A (5V x 130mA)	0.65W (5V x 130mA)	1.8W (5V x 370mA)	
Thermal Sensor	Wide temperature model only	Wide temperature model only	Wide temperature model only	Wide temperature model only	Wide temperature model only	
ATA Security	Yes	Yes	Yes	Yes	Yes	
S.M.A.R.T	Yes	Yes	Yes	Yes	Yes	
Dimensions (mm)	20.9 x 39.5 x 7.9	25.3 x 41.5 x 6.8	32.5 x 29.5 x 8.0	18.1 x 30.5 x 12	18.0 x 30.3 x 12.5	
Environment	Vibration: 20G@7~2000Hz, Shock: 1500G@0.5ms, Storage Temperature: -55°C ~ +95°C, MTBF: >3 million hours					
P/N	Standard (0°C~+70°C)	IFM-3010IS-1GB IFM-3010IS-2GB IFM-3010IS-4GB IFM-3010IS-8GB IFM-3010IS-16GB IFM-3010IS-32GB	IFM-3320IM-8GB-R21 IFM-3320IM-16GB-R21 IFM-3320IM-32GB-R21 IFM-3320IM-64GB-R21 IFM-3320IM-128GB-R21	IFM-3010IL-1GB IFM-3010IL-2GB IFM-3010IL-4GB IFM-3010IL-8GB IFM-3010IL-16GB IFM-3010IL-32GB	IFM-3010IPS-1GB IFM-3010IPS-2GB IFM-3010IPS-4GB IFM-3010IPS-8GB IFM-3010IPS-16GB IFM-3010IPS-32GB	IFM-3020IPSM-8GB-R21 IFM-3020IPSM-16GB-R21 IFM-3020IPSM-32GB-R21 IFM-3020IPSM-64GB-R21 IFM-3020IPSM-128GB-R21
	Wide Temperature (-40°C~+85°C)	IFM-3010WS-1GB IFM-3010WS-2GB IFM-3010WS-4GB IFM-3010WS-8GB IFM-3010WS-16GB IFM-3010WS-32GB	IFM-3320WM-8GB-R21 IFM-3320WM-16GB-R21 IFM-3320WM-32GB-R21 IFM-3320WM-64GB-R21 IFM-3320WM-128GB-R21	IFM-3010WL-1GB IFM-3010WL-2GB IFM-3010WL-4GB IFM-3010WL-8GB IFM-3010WL-16GB IFM-3010WL-32GB	IFM-3010WPS-1GB IFM-3010WPS-2GB IFM-3010WPS-4GB IFM-3010WPS-8GB IFM-3010WPS-16GB IFM-3010WPS-32GB	IFM-3020WPSM-8GB-R21 IFM-3020WPSM-16GB-R21 IFM-3020WPSM-32GB-R21 IFM-3020WPSM-64GB-R21 IFM-3020WPSM-128GB-R21

# Industrial SSD Series

## Breakthrough Technology of IFD-2530ISMD

With the release of the brand-new designed firmware algorithm, and IFD-2530ISMD offer outstanding read and write performance and extended lifespan, and are compliant with the JEDEC 219 specifications. In addition, with the iData Guard Technology, IFD-2530ISMD support data integrity in the event of abnormal power failure. The wide operating temperature ranges from -40 °C to 85 °C.



## Features of IFD-2540A2M & IFD-2530ISMD

IFD-2540A2M and IFD-2530ISMD provide a wide range demand of capacity. IFD-2530ISMD even supports large capacity up to 1TB.

	IFD-2540A2M	IFD-2530ISMD
DRAM-less Design	•	
Price	•	
Random Transfer Performance	• R: 31,000 IOPS/W: 40,000 IOPS (128GB)	• R: 70,000 IOPS/W: 64,000 IOPS (128GB)
Easy to Design in Small Form Factors	•	
Low Power Consumption	•	•
TRIM	•	•

Model Name	2.5" SATA 6Gb/s IFD-2530ISMD	2.5" SATA 6Gb/s IFD-2540A2M
Picture		
Key Features	<ol style="list-style-type: none"> <li>1. EverGreen L<sup>2</sup> architecture</li> <li>2. 7mm height mechanical design</li> <li>3. Excellent random performance</li> </ol>	<ol style="list-style-type: none"> <li>1. 7mm height mechanical design</li> <li>2. Low power consumption</li> <li>3. Budget-friendly MLC-based solution</li> </ol>
Interface	SATA 6Gb/s	SATA 6Gb/s
Flash Type	MLC	MLC
Capacity (GB)	8GB~1TB	32GB~1TB
Sequential R/W	520/450	560/510
Max. Power Consumption	5W (5V x 1A)	0.5W (5V x 100 mA)
Thermal Sensor	Wide temperature model only	Wide temperature model only
ATA Security	Yes	Yes
S.M.A.R.T	Yes	Yes
Dimensions (mm)	70.0 x 100.0 x 6.8	69.85 x 100 x 6.9
Environment	Vibration: 20G@7~2000Hz, Shock: 1500G@0.5ms, Storage Temperature: -55°C ~ +95°C, MTBF: >3 million hours	
P/N	Standard (0°C~+70°C)	IFD-2530ISMD-8GB-R20 IFD-2530ISMD-16GB-R20 IFD-2530ISMD-32GB-R20 IFD-2530ISMD-64GB-R20 IFD-2530ISMD-128GB-R20 IFD-2530ISMD-256GB-R20 IFD-2530ISMD-512GB-R20 IFD-2530ISMD-1TB-R20
	Wide Temperature (-40°C~+85°C)	IFD-2540A2M-32GB-R20 IFD-2540A2M-64GB-R20 IFD-2540A2M-128GB-R20 IFD-2540A2M-256GB-R20 IFD-2540A2M-512GB-R20 IFD-2540A2M-1TB-R20

# Industrial SSD Series

## Over-provisioning for SSDs

### Maintain the high performance of SSDs with over-provisioning

All SSDs feature a reserved space for over-provisioning (OP). This allows the SSD to continue writing data without affecting performance when the SSD is almost out of storage space. However, if this reserved space is used up, the SSD needs to reorganize its internal data before any new data can be written. This data reorganization can have drastic impacts to both SSD performance and lifetime. SSDs with insufficient OP reserved space is like a restaurant where the staff do not have enough time to clean up the tables left by customers, resulting in guests waiting at the door. With additional reserved space for OP, it is like opening separate tables for new customers.

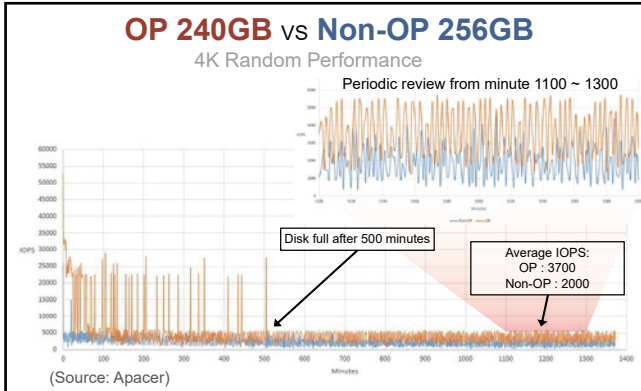

Due to cost considerations of SSD manufacturers and general usage cases, SSDs intended for general consumers only provide a minimal reserved space for OP. For a larger OP reserved space, expensive enterprise-level SSDs are required. Additional space for over-provisioning can be reserved at the OS level (or by other software). Research by mainstream SSD manufacturers has shown that on a 512 GB consumer-level SSD, an additional 5% reserved space for OP can more than double the lifespan (write endurance) of an SSD, and improve performance by nearly 100%.

SSDs with over-provisioning technology, while sacrificing a portion of the physical capacity, have more free blocks for wear-leveling and garbage collection to further improve lifespan and overall performance.

The 3D 2.5" SATA SSD is SATA 6Gb/s solid state disk, which delivers excellent performance, especially in random data transfer rate, and which offers reliability making it the ideal solution for a variety of applications, including embedded system, industrial computing, and enterprise field. The 3D 2.5" SSD not only performs unmatched performance but also designed with industrial storage technologies to ensure the data integrity and highest levels of reliability.

## Features of IFD-2540A3T

IFD-2540A3T provide a wide range demand of capacity. I

IFD-2540A3T															
DRAM-less Design	•														
Price	•														
Random IOPS	•														
Easy to Design in SFF	•														
Low Power Consumption	•														
TRIM	•														
R: 80,000 IOPS/W: 71,000 IOPS (128GB)															
2.5" SATA 6Gb/s IFD-2540A3T															
Model Name	2.5" SATA 6Gb/s IFD-2540A3T														
Picture															
Key Features	<ol style="list-style-type: none"> <li>LDPC ECC engine Internal Flash DIE RAID engine</li> <li>End to End Data Protection Original Toshiba Industrial grade 3D TLC</li> <li>End to End Power Protection Optional iCell</li> </ol>														
Interface	SATA 6Gb/s														
Flash Type	3D TLC														
Capacity (GB)	30GB~960GB														
Sequential R/W	560/515														
Max. Power Consumption	2.6W (5V x 525mA)														
Thermal Sensor	Yes														
ATA Security	Yes														
S.M.A.R.T	Yes														
Dimensions (mm)	69.8 x 100.0 x 6.8														
Environment	Vibration: 20G@7~2000Hz, Shock: 1500G@0.5ms, Storage Temperature: -55°C ~ +95°C, MTBF: >3 million hours														
P/N	<table border="0"> <tr> <td><b>Standard (0°C~+70°C):</b></td> <td><b>Wide Temperature (-40°C~+85°C):</b></td> </tr> <tr> <td>IFD-2540A3T-30GB-R20</td> <td>IFD-2540IW3T-1TB-R20</td> </tr> <tr> <td>IFD-2540A3T-60GB-R20</td> <td>IFD-2540IW3T-512GB-R20</td> </tr> <tr> <td>IFD-2540A3T-120GB-R20</td> <td>IFD-2540IW3T-256GB-R20</td> </tr> <tr> <td>IFD-2540A3T-240GB-R20</td> <td>IFD-2540IW3T-128GB-R20</td> </tr> <tr> <td>IFD-2540A3T-480GB-R20</td> <td>IFD-2540IW3T-64GB-R20</td> </tr> <tr> <td>IFD-2540A3T-960GB-R20</td> <td>IFD-2540IW3T-32GB-R20</td> </tr> </table>	<b>Standard (0°C~+70°C):</b>	<b>Wide Temperature (-40°C~+85°C):</b>	IFD-2540A3T-30GB-R20	IFD-2540IW3T-1TB-R20	IFD-2540A3T-60GB-R20	IFD-2540IW3T-512GB-R20	IFD-2540A3T-120GB-R20	IFD-2540IW3T-256GB-R20	IFD-2540A3T-240GB-R20	IFD-2540IW3T-128GB-R20	IFD-2540A3T-480GB-R20	IFD-2540IW3T-64GB-R20	IFD-2540A3T-960GB-R20	IFD-2540IW3T-32GB-R20
<b>Standard (0°C~+70°C):</b>	<b>Wide Temperature (-40°C~+85°C):</b>														
IFD-2540A3T-30GB-R20	IFD-2540IW3T-1TB-R20														
IFD-2540A3T-60GB-R20	IFD-2540IW3T-512GB-R20														
IFD-2540A3T-120GB-R20	IFD-2540IW3T-256GB-R20														
IFD-2540A3T-240GB-R20	IFD-2540IW3T-128GB-R20														
IFD-2540A3T-480GB-R20	IFD-2540IW3T-64GB-R20														
IFD-2540A3T-960GB-R20	IFD-2540IW3T-32GB-R20														



# Industrial CFast & CF Card Series

## ■ Similar size, different read and write speeds

With a similar size, CFast is mainly different from CF card in its interface, connector, and most importantly, faster read and write speeds. CFast, with SATA 6Gb/s interface and 7-pin plus 17-pin connector, offers data transfer rates of sequential reads up to 470 MB/sec and of sequential writes up to 250 MB/sec. CF card, with PATA interface and 50-pin CF connector, offers data transfer rates of sequential reads up to 100 MB/sec and of sequential writes up to 95 MB/sec.

## ■ ATA security for CF card

The optional ATA Security Mode feature set is a password system that restricts access to user data stored on a device. The purpose is to prevent unauthorized access or a virus.



CFast 3SE: Pin Directions

- Pin S6: Tx+
- Pin S5: Tx-
- Pin S3: Rx-
- Pin S2: Rx+

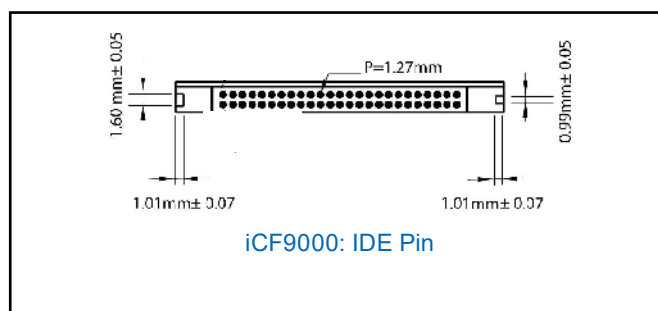

iCF9000: IDE Pin

Model Name	ICF-9000	ICF-2000	ICF-1000		
Picture					
Capacity	4GB~32GB	512MB~8GB	128MB~8GB	128MB~16GB	
Sequential R/W (Max.)	110/100 MB/sec	40/30 MB/sec	40/28 MB/sec	30/15 MB/sec	
Flash Type	SLC	SLC	SLC	SLC	
IDE Transfer Mode	PIO mode 0-6 MwDMA mode 0-4 UltraDMA mode 0-7	PIO mode 0-4 MwDMA mode 0-4 UltraDMA mode 0-4	PIO mode 0-4 MwDMA mode 0-4 UltraDMA mode 0-4	PIO mode 0-6 MwDMA mode 0-4 UltraDMA mode 0-4	
Operating Temp.	0°C~+70°C (Standard)/-40°C~+85°C (Industrial)				
Storage Temp.	-55°C~+95°C			-40°C~+100°C	
Vibration/Shock (7/2000Hz)/(0.5ms)	1500G/0.5ms			1500G/0.5ms	
DC Power Input	ICF: +3.3V~+5V single power supply operation			Supply voltage: 3.3V & 5V	
Power Consumption (Max.)	0.75W (5V x 125mA@210mA)			95 mA	
Dimensions (mm)	42.8 x 36.4 x 3.3			42.8 x 36.4 x 3.3	
ATA Security	Yes	Yes	Yes	Yes	
S.M.A.R.T	Yes	Yes	Yes	No	
P/N	STD (0°C~+70°C)	ICF-9000CD-4GB ICF-9000CD-8GB ICF-9000CD-16GB ICF-9000CD-32GB	ICF-2000IPS-512MB ICF-2000IPD-1GB ICF-2000IPD-2GB ICF-2000IPD-4GB ICF-2000IPD-8GB	ICF-1000IPD-1GB-R20 ICF-1000IPD-2GB-R20 ICF-1000IPD-4GB-R20 ICF-1000IPD-8GB-R20	ICF-1000IA-128MB-R20 ICF-1000IA-256MB-R20 ICF-1000IA-512MB-R20 ICF-1000IA-1GB-R20 ICF-1000IA-2GB-R20 ICF-1000IA-4GB-R20 ICF-1000IA-8GB-R20
	WT (-40°C~+85°C)	ICF-9000WD-4GB ICF-9000WD-8GB ICF-9000WD-16GB ICF-9000WD-32GB	ICF-2000WPS-512MB ICF-2000WPD-1GB ICF-2000WPD-2GB ICF-2000WPD-4GB ICF-2000WPD-8GB	ICF-1000WPD-1GB-R20 ICF-1000WPD-2GB-R20 ICF-1000WPD-4GB-R20 ICF-1000WPD-8GB-R20	ICF-1000WA-128MB-R20 ICF-1000WA-256MB-R20 ICF-1000WA-512MB-R20 ICF-1000WA-1GB-R20 ICF-1000WA-2GB-R20 ICF-1000WA-4GB-R20 ICF-1000WA-8GB-R20

# Industrial Mini PCIe DOM & mSATA Series

## Co-layout design of Mini PCIe DOM and mSATA

For manufacturers or system integrators, the exciting benefit is they can have a circuit board with co-layout design of Mini PCIe DOM and mSATA. This feature allows users to enjoy wider applications by installing optional Mini PCIe DOM or mSATA in the same placement site.

## Mini PCIe DOM: For conventional main board, better performance than CF card

We have realized IPC customers need a steady supply for their design-in cases by using Mini PCIe DOM or CF card as boot drive or storage. However, Mini PCIe DOM obviously has better performance in read/write over 4 times than CF card. Boasting its easy use in plug-and-play and driverless (Windows XP and above) capabilities, the Mini PCIe DOM is no doubt the best choice for the conventional motherboard. In the following table, we recommend one cost-effective MLC model and one reliable SLC model.

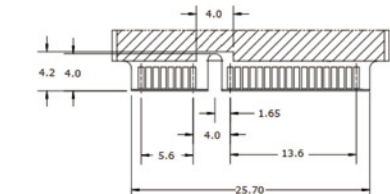

**mini PCIe DOM 1ME: Pin Directions**

Pin33: PETp0

Pin31: PETn0

Pin23: PERn0

Pin25: PERp0

## mSATA: For space-limited main board, up to read/write speed of 470/220 MB/sec

Nowadays, more and more compact gadgets are designed to satisfy eager users. Smaller than a business card, the mSATA has become the must-have storage to deliver instant data transfer.

In the following table, we recommend five models categorized by the flash type and size.

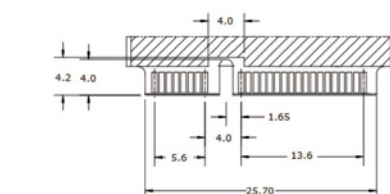



**mSATA 3SE: Pin Directions**

Pin33: Rx+

Pin31: Rx-

Pin23: Tx+

Pin25: Tx-

Model Name	IPE-5300IM/WM	IPE-5330A3T/AW3T	IPE-5330A2M/AW2M	
Picture				
Key Features	1. Excellent data transfer speed 2. High quality SLC- based solution	1. SATA III solution for industrial field 2. High IOPS 3. DEVSLP supported	1. Excellent data transfer speed and IOPS 2. Budget- friendly MLC-based solution	
Interface	SATA 6Gb/s	SATA 6Gb/s	SATA 6Gb/s	
Flash Type	SLC	TLC	MLC	
Capacity (GB)	2GB~32GB	30GB~960GB	32GB~512GB	
Sequential R/W	470/250	510/480	560/510	
Max.Power Consumption	1.2W (3.3V x 360mA)	1.7W (3.3V x 540 mA)	3W (3.3V x 935mA)	
Thermal Sensor	Wide temperature model only	Yes	Yes	
ATA Security	Yes	Yes	Yes	
S.M.A.R.T	Yes	Yes	Yes	
Dimensions (mm)	29.8 x 50.8 x 4.4	29.85 x 50.8 x 3.7	29.8 x 50.8 x 4.4	
Environment	Vibration: 20G@7~2000Hz, Shock: 1500G@0.5ms, Storage Temperature: -55°C ~ +95°C, MTBF: >3 million hours			
P/N	Standard (0°C~+70°C)	IPE-5300IM-1GB IPE-5300IM-2GB IPE-5300IM-4GB IPE-5300IM-8GB IPE-5300IM-16GB IPE-5300IM-32GB	IPE-5330A3T-30GB-R20 IPE-5330A3T-60GB-R20 IPE-5330A3T-120GB-R20 IPE-5330A3T-240GB-R20 IPE-5330A3T-480GB-R20 IPE-5330A3T-960GB-R20	IPE-5330A2M-32GB-R20 IPE-5330A2M-64GB-R20 IPE-5330A2M-128GB-R20 IPE-5330A2M-256GB-R20 IPE-5330A2M-512GB-R20
	Wide Temperature (-40°C~+85°C)	IPE-5300WM-1GB IPE-5300WM-2GB IPE-5300WM-4GB IPE-5300WM-8GB IPE-5300WM-16GB IPE-5300WM-32GB	IPE-5330AW3T-30GB-R20 IPE-5330AW3T-60GB-R20 IPE-5330AW3T-120GB-R20 IPE-5330AW3T-240GB-R20 IPE-5330AW3T-480GB-R20 IPE-5330AW3T-960GB-R20	IPE-5330AW2M-32GB-R20 IPE-5330AW2M-64GB-R20 IPE-5330AW2M-128GB-R20 IPE-5330AW2M-256GB-R20 IPE-5330AW2M-512GB-R20

# M.2 SATA III

M.2, formerly known as the Next Generation Form Factor (NGFF), M.2's more flexible physical specification allows different module widths and lengths, and, paired with the availability of more advanced interfacing features, makes the M.2 more suitable than mSATA for solid-state storage applications in general and particularly for the use in small system.

## ■ Features

- Adopted SATA 6Gb/s interface, complaint with M.2 (NGFF) type 2242 and 2280
- Excellent data transfer speed in small form factor
- iCell technology for data protection
- Supports iSMART disk health monitoring

## ■ Benefits

- The small form factor of M.2 (S42) saves about 40% of PCB dimension, comparing to the Mini PCIe form factor
- Innodisk's exclusive iData Guard ensures reliable data transfer in the event of an abnormal power failure
- Fully compliant with industrial standard
- Suitable for ultra-thin or compact system

## ■ M.2 form factor used on SSD

- Key A version is intended to support Wi-Fi+BT+NFC and/or WiGig Combo solution
- Key B is intended to support WWAN+GNSS, SSD and other add-in solutions
- Key E is intended to support Wi-Fi+BT+NFC or GNSS solution
- Key M is intended for SSD devices only



Model Name	IM2SE-2242IM	IM2SE-2280I2M	IM2SE-2242I3T	IM2SE-2280I3T	IM2SE-2242I3TD	IM2SE-2280I3TD	
Picture							
Type	2242-D2-B-M	2280-D2-B-M	2242-D2-B-M	2280-D2-B-M	2242-D2-B-M	2280-D2-B-M	
Key Features	1. Design with LDPC ECC engine 2. Budget-Friendly MLC-based solution		1. Truly industrial optimized firmware with 3D NAND flash 2. Advanced LDPC ECC engine 3. Internal RAID Technology 4. DRAM-less , high level data integrity 5. Excellent data transfer speed		1. Extreme SEQ and random performance 2. Advanced LDPC ECC engine 3. Flash DIE RAID function 4. AES 256 5. End to End data path protection		
Interface	SATA 6Gb/s	SATA 6Gb/s	SATA 6Gb/s	SATA 6Gb/s	SATA 6Gb/s	SATA 6Gb/s	
Flash Type	MLC	MLC	3D TLC	3D TLC	3D TLC	3D TLC	
Capacity (GB)	8GB~256GB	32GB~1TB	32GB~512GB	32GB~1TB	128GB~512GB	128GB~1TB	
Sequential R/W	530/210	530/450	530/210	520/210	550/340	540/500	
Max. Power Consumption	1.4W (3.3V x 422 mA)	4.6W (3.3V x 1.4A)	1.6W (3.3V x 475 mA)	2.0W (3.3V x 614 mA)	2.4W (3.3V x 740 mA)	2.6W (3.3V x 800 mA)	
Thermal Sensor	Yes	Yes	Yes	Yes	Yes	Yes	
ATA Security	Yes	Yes	Yes	Yes	Yes	Yes	
S.M.A.R.T	Yes	Yes	Yes	Yes	Yes	Yes	
Dimensions (mm)	22.0 x 42.0 x 3.2	22.0 x 80.0 x 3.5	22.0 x 42.0 x 3.2	22.0 x 80.0 x 3.2	69.8 x 100.0 x 6.8	22.0 X 80.0 X 3.0	
Environment	Vibration: 20G@7~2000Hz, Shock: 1500G@0.5ms, Storage Temperature: -55°C ~ +95°C, MTBF: >3 million hours						
P/N	Standard (0°C~+70°C)	IM2SE-2242IM-256GB-R10 IM2SE-2242IM-128GB-R10 IM2SE-2242IM-64GB-R10 IM2SE-2242IM-32GB-R10 IM2SE-2242IM-16GB-R10 IM2SE-2242IM-8GB-R10	IM2SE-2280I2MD-1TB-R10 IM2SE-2280I2MD-512GB-R10 IM2SE-2280I2MD-256GB-R10 IM2SE-2280I2MD-128GB-R10 IM2SE-2280I2MD-64GB-R10 IM2SE-2280I2MD-32GB-R10	IM2SE-2242I3T-512GB-R10 IM2SE-2242I3T-256GB-R10 IM2SE-2242I3T-128GB-R10 IM2SE-2242I3T-64GB-R10 IM2SE-2242I3T-32GB-R10	IM2SE-2280I3T-1TB-R10 IM2SE-2280I3T-512GB-R10 IM2SE-2280I3T-256GB-R10 IM2SE-2280I3T-128GB-R10 IM2SE-2280I3T-64GB-R10 IM2SE-2280I3T-32GB-R10	IM2SE-2242I3TD-512GB-R10 IM2SE-2242I3TD-256GB-R10 IM2SE-2242I3TD-128GB-R10	IM2SE-2280I3TD-1TB-R10 IM2SE-2280I3TD-512GB-R10 IM2SE-2280I3TD-256GB-R10 IM2SE-2280I3TD-128GB-R10
	Wide Temperature (-40°C~+85°C)	IM2SE-2242WM-256GB-R10 IM2SE-2242WM-128GB-R10 IM2SE-2242WM-64GB-R10 IM2SE-2242WM-32GB-R10 IM2SE-2242WM-16GB-R10 IM2SE-2242WM-8GB-R10	IM2SE-2280IW2MD-1TB-R10 IM2SE-2280IW2MD-512GB-R10 IM2SE-2280IW2MD-256GB-R10 IM2SE-2280IW2MD-128GB-R10 IM2SE-2280IW2MD-64GB-R10 IM2SE-2280IW2MD-32GB-R10	IM2SE-2242IW3T-512GB-R10 IM2SE-2242IW3T-256GB-R10 IM2SE-2242IW3T-128GB-R10 IM2SE-2242IW3T-64GB-R10 IM2SE-2242IW3T-32GB-R10	IM2SE-2280IW3T-1TB-R10 IM2SE-2280IW3T-512GB-R10 IM2SE-2280IW3T-256GB-R10 IM2SE-2280IW3T-128GB-R10 IM2SE-2280IW3T-64GB-R10 IM2SE-2280IW3T-32GB-R10	IM2SE-2242IW3TD-512GB-R10 IM2SE-2242IW3TD-256GB-R10 IM2SE-2242IW3TD-128GB-R10	IM2SE-2280IW3TD-1TB-R10 IM2SE-2280IW3TD-512GB-R10 IM2SE-2280IW3TD-256GB-R10 IM2SE-2280IW3TD-128GB-R10

## M.2 PCIeIII





M.2 SSD is an NVMe Express DRAM-less SSD designed as the standard M.2 form factor with PCIe interface. M.2 SSD supports PCIe Gen III x2, and it is compliant with NVMe 1.3 providing excellent performance. Moreover, it adopts industrial grade NAND Flash which provides high endurance and reliability. With sophisticated error detection and correction (ECC) functions, the module can ensure full End-to-end Data Path Protection that secures the data transmission between the host system and NAND flash.

### ■ Features

- PCIe Gen. III x2, NVMe 1.3
- Anti-vibration mechanical design
- LDPC ECC engine supported.
- End-to-end Data Path Protection
- iCell supported

### ■ Benefits

- Excellent data transfer speed
- Zero mechanical interference
- Enhanced power failure protection
- Native PCIe device without driver in needed.

Model Name	IPE-G32-2242I2M	IPE-G32-2280I2M	IPE-G32-2242I3T	IPE-G32-2280I3T	
Picture					
Key Features	1. Type 2242-D2-B-M 2. Heat-less controller chip 3. Support NVM3 v1.3 4. End-to-End data path protection 5. iDATA guard power protection	1. Type 2280-D2-B-M 2. Heat-less controller chip 3. Support NVM3 v1.3 4. End-to-End data path protection 5. iDATA guard power protection	1. Dram-Less solution 2. Heat-less controller chip 3. Support NVM3 v1.3 4. End-to-End data path protection	1. Dram-Less solution 2. Heat-less controller chip 3. Support NVM3 v1.3 4. End-to-End data path protection	
Interface	PCIe Gen. III x2	PCIe Gen. III x2	PCIe Gen. III x2	PCIe Gen. III x2	
Flash Type	MLC	MLC	3D TLC	3D TLC	
Capacity (GB)	32GB~256GB	32GB~512GB	64GB~512GB	64GB~1TB	
Sequential R/W	1300/360	1300/490	1300/680	1300/680	
Max. Power Consumption	2.9W (3.3V x 880mA)	3.72W (3.3 x 1130mA)	2.31W(3.3V x 700mA)	3W(3.3V x 910mA)	
Thermal Sensor	Yes	Yes	Standard: Yes, Wide Temperature: Yes	Standard: Yes, Wide Temperature: Yes	
ATA Security	Yes	No	No	No	
S.M.A.R.T	Yes	Yes	Yes	Yes	
Dimensions (mm)	22.0 x 42.0 x 3.5	22.0 x 80.0 x 3.5	22.0 x 42.0 x 3.5	22.0 x 80.0 x 3.5	
Environment	Vibration: 20G@7~2000Hz, Shock: 1500G@0.5ms, Storage Temperature: -55°C ~ +95°C, MTBF: >3 million hours				
P/N	Standard (0°C~+70°C)	IPE-G32-2242I2M-256GB-R10 IPE-G32-2242I2M-128GB-R10 IPE-G32-2242I2M-64GB-R10 IPE-G32-2242I2M-32GB-R10	IPE-G32-2280I2M-512GB-R10 IPE-G32-2280I2M-256GB-R10 IPE-G32-2280I2M-128GB-R10 IPE-G32-2280I2M-64GB-R10 IPE-G32-2280I2M-32GB-R10	IPE-G32-2242I3T-512GB-R10 IPE-G32-2242I3T-256GB-R10 IPE-G32-2242I3T-128GB-R10 IPE-G32-2242I3T-64GB-R10	IPE-G32-2280I3T-1TB-R10 IPE-G32-2280I3T-512GB-R10 IPE-G32-2280I3T-256GB-R10 IPE-G32-2280I3T-128GB-R10 IPE-G32-2280I3T-64GB-R10
	Wide Temperature (-40°C~+85°C)	IPE-G32-2242IW2M-256GB-R10 IPE-G32-2242IW2M-128GB-R10 IPE-G32-2242IW2M-64GB-R10 IPE-G32-2242IW2M-32GB-R10	IPE-G32-2280IW2M-512GB-R10 IPE-G32-2280IW2M-256GB-R10 IPE-G32-2280IW2M-128GB-R10 IPE-G32-2280IW2M-64GB-R10 IPE-G32-2280IW2M-32GB-R10	IPE-G32-2242IW3T-512GB-R10 IPE-G32-2242IW3T-256GB-R10 IPE-G32-2242IW3T-128GB-R10 IPE-G32-2242IW3T-64GB-R10	IPE-G32-2280IW3T-1TB-R10 IPE-G32-2280IW3T-512GB-R10 IPE-G32-2280IW3T-256GB-R10 IPE-G32-2280IW3T-128GB-R10 IPE-G32-2280IW3T-64GB-R10

## Intel® 2.5" SSD Solution



Key Features	1. 7mm height mechanical design 2. Low power consumption	Max. Power Consumption	165mw (5V*33mA)
Interface	SATA 6Gb/s	Thermal Sensor	0° C~70°C
Flash Type	MLC	ATA Security	Yes
Capacity (GB)	60GB~480GB	S.M.A.R.T	Yes
Sequential R/W	540/490	Dimensions (mm)	70 x 100 x 7
Environment	Vibration: 2.17 G@5-700 Hz, Shock: 1500G@0.5ms, Storage Temperature: 0° C~70° C, MTBF: ≥1.2 million hours		

# Ensuring the Best System Performance

IEI provide complete product line of industrial

## Features

- Refresh → TREFI=7.8ms from -40°C~+85°C
- 30μ" Gold Finger
- Stern Test of Parameter
- High Reliability

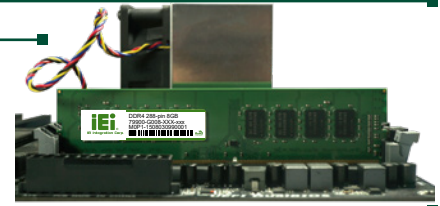

## DDR4 DIMM

### Features

- Low Power
- Major on Third
- Thermal Sensor Design Ready
- 100% System Level Test

### DDR4 DIMM

Module Speed	DIMM	SO-DIMM	CAS Latency
2133 MHz	288-pin	260-pin	CL13

### SO-DIMM



### Long-DIMM

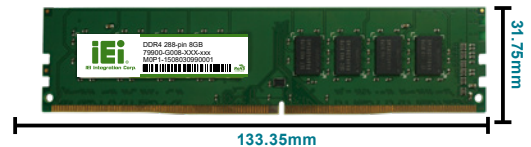

## Ordering Information



DDR4 SO-DIMM	Description
	DDR4 2400 4GB SO-DIMM CL17 512M*8
	DDR4 2400 8GB SO-DIMM CL17 512M*8
	DDR4 2400 8GB SO-DIMM CL17 1G*8
	DDR4 2400 16GB SO-DIMM CL17 1G*8
	DDR4 2666 4GB SO-DIMM CL17 512M*8
	DDR4 2666 8GB SO-DIMM CL17 512M*8
	DDR4 2666 8GB SO-DIMM CL17 1G*8
	DDR4 2666 16GB SO-DIMM CL17 1G*8

DDR4 Long-DIMM	Description
	DDR4 2400 4GB Long-DIMM CL17 512M*8
	DDR4 2400 8GB Long-DIMM CL17 512M*8
	DDR4 2400 8GB Long-DIMM CL17 1G*8
	DDR4 2400 16GB Long-DIMM CL17 1G*8
	DDR4 2666 4GB Long-DIMM CL17 512M*8
	DDR4 2666 8GB Long-DIMM CL17 512M*8
	DDR4 2666 8GB Long-DIMM CL17 1G*8
	DDR4 2666 16GB Long-DIMM CL17 1G*8

## DDR3 W/T & Commercial ECC Thermal Sensor Solution

Module Speed	1600 MHz
DIMM	240-pin
SO-DIMM	204-pin
CAS Latency	CL11

### DDR3 ECC SO-DIMM

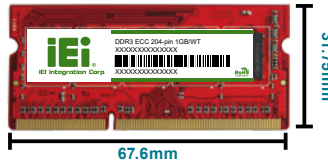

### DDR3 ECC Long-DIMM



## Ordering Information

DDR3 SO-DIMM W/T	Description
	DDR3 1600 1GB ECC SO-DIMM CL11 128M*8
	DDR3 1600 2GB ECC SO-DIMM CL11 256M*8
	DDR3 1600 4GB ECC SO-DIMM CL11 256M*8
	DDR3 1600 8GB ECC SO-DIMM CL11 256M*8

DDR3 DIMM W/T	Description
	DDR3 1600 2GB DIMM CL11 256M*8
	DDR3 1600 4GB DIMM CL11 256M*8
	DDR3 1600 8GB DIMM CL11 256M*8
	DDR3 1600 16GB DIMM CL11 256M*8

## DDR3 W/T Solution

Module Speed	1600 MHz
DIMM	240-pin
SO-DIMM	204-pin
CAS Latency	CL11

### DDR3 SO-DIMM

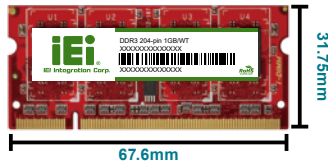

### DDR3 Long-DIMM



## Ordering Information

DDR3 SO-DIMM W/T	Description
	DDR3 1600 1GB SO-DIMM, ProMOS, 128M*8
	DDR3 1600 2GB SO-DIMM, ProMOS, 128M*8
	DDR3 1600 2GB SO-DIMM, Micron, 256M*8
	DDR3 1600 4GB SO-DIMM, Micron, 256M*8
	DDR3 1600 4GB SO-DIMM, ProMOS, 512M*8
	DDR3 1600 8GB SO-DIMM, ProMOS, 512M*8

DDR3 DIMM W/T	Description
	DDR3 1600 2GB DIMM, ProMOS, 128M*8
	DDR3 1600 2GB DIMM, Micron, 256M*8
	DDR3 1600 4GB DIMM, Micron, 256M*8
	DDR3 1600 4GB DIMM, ProMOS, 512M*8
	DDR3 1600 8GB DIMM, ProMOS, 512M*8

## DDR2 W/T Solution

Module Speed	800 MHz
DIMM	240-pin
SO-DIMM	200-pin
CAS Latency	CL6

### DDR2 SO-DIMM

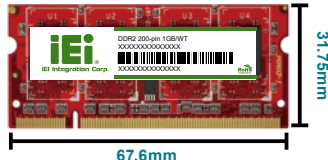

### DDR2 DIMM (Low Profile)



## Ordering Information

DDR2 SO-DIMM W/T	Description
	DDR2 667 1GB SO-DIMM, ProMOS, 128M*8
	DDR2 800 1GB SO-DIMM, ProMOS, 128M*8
	DDR2 800 2GB SO-DIMM, ProMOS, 128M*8

DDR2 DIMM W/T	Description
	DDR2 800 1GB DIMM, ProMOS, 128M*8
	DDR2 800 2GB DIMM, ProMOS, 128M*8

DDR SO-DIMM W/T	Description
	DDR400 1GB SO-DIMM, ProMOS, 64M*8



# Lifespan Evaluation of Flash Products From Endurance to iSMART

## Endurance of different flash types - SLC and MLC

SLC is more reliable and has longer endurance than MLC.

MLC is cost-saving alternative to SLC to replace the traditional HDD.

## iSMART, the proprietary disk health monitoring tool, provides easy access, in-depth information for embedded applications

iSMART can monitor all our flash products in a system. It provides clear and easy to understand warnings, numbers, charts and graphics to enable system integrators and users to check storage device health, performance, temperature, free space, and status at a glance. Also, it can alert users with the remaining service lifetime of Innodisk drives, so that they can replace a device in plenty of time to avoid any potential issues.

Besides providing critical disk information, iSMART also offers convenience through e-mail alerts and one-touch feature. Additionally, iSMART provides dynamic power management, advancing green design goals for lower power consumption, such as with a 35% of power saving in idle mode.

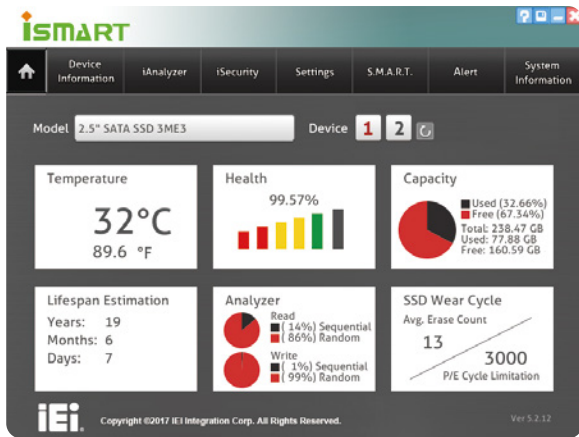

**Dashboard**

The Dashboard's home tab aims to provide a summary or quick snapshot of each installed disks in the system. This page offers accurate data information regarding Temperature, Health, Capacity, Lifespan, iAnalyzer, and Notifications.

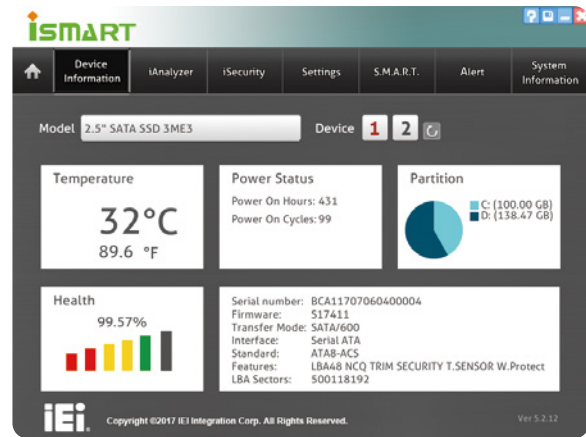

**Device Information**

The Device Information page provides additional functions, such as Power Status, Partitions, and detailed information of the device such as Serial Number, Firmware Version, Interface, and Features. To learn more about SMART information, go to SMART values and refer to the SMART tab.

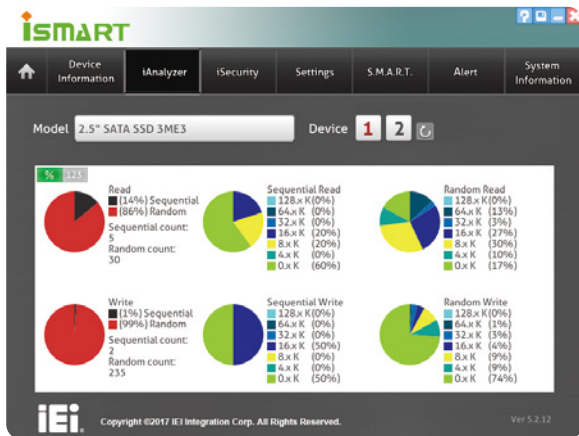

**iAnalyzer**

When activated, the iAnalyzer tab displays the read/write behaviors of the SSD in real time. This allows the user to understand their application usage of the SSD. Sequential and Random I/Os are easily broken down into percentages making them easy to read.

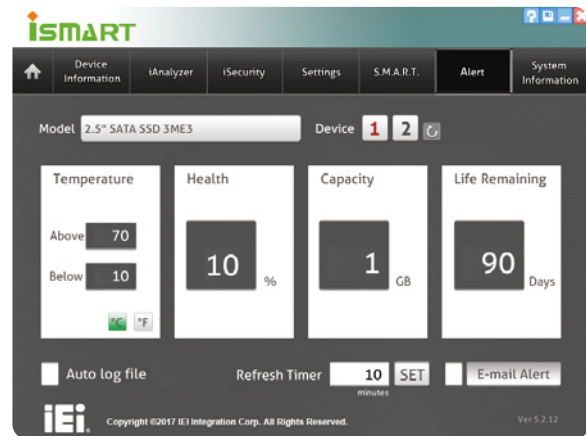





**Alert**

The Alert tab helps the user set trigger points with Temperature, Health percentage, Remaining Capacity or Life Remaining. If these trigger points exceed their boundaries, the iSMART utility can send a warning and email to the user notifying them that something may fail.

## Drive Cage *Standard 3.5" Device in 5.25" Drive Bay Solutions*

Following the traditional industrial system needs for stability, durability and toughness for storage drive operating condition, IEI provides various kinds of standard 3.5" device in 5.25" removable drive bay and modules for different demands.

	SATA / IDE / SSD Solution		
			
<b>Model Name</b>	<b>XWC-410030507220-RS</b>	<b>XWC-410030507230-RS</b>	<b>RHD-302SATA-R20</b>
<b>Dimensions (L x W x H) (mm)</b>	150 x 146 x 42	150 x 146 x 42	202 x 146 x 86
<b>Material</b>	Aluminum	Aluminum	Aluminum alloy
<b>Interface</b>	SATA / IDE / SSD	SATA / IDE / SSD	SATA III / SAS 2.0
<b>Data Transfer Rate</b>			SAS 2.0 / SATA III 6Gbps
<b>Drive Bay Space</b>	One 5.25" drive bay	One 5.25" drive bay	2 x 5.25" Device Bay for 3 x 2.5" or 3.5" Hard Drive
<b>HDD Type</b>	Internal 3.5" device bay	Internal 3.5" device bay	2.5" or 3.5" Hard Drive
<b>Cooling Fan</b>			8 cm
<b>Hot Swap</b>	No	No	Yes
<b>Keylock</b>	No	No	No
<b>Signal Out</b>	No	No	SATA III 7-Pin
<b>Color</b>	Black	White	Black
<b>Gross Weight</b>	0.2 kg	0.2 kg	1.3kg

	SATA Solution			
				
<b>Model Name</b>	<b>RHD-102SATA-R20</b>	<b>RHD-102DW-R20</b>	<b>RHD-101SATA-R20</b>	<b>RHD-104SATA-R20</b>
<b>Dimensions (L x W x H) (mm)</b>	140 x 101.6 x 25	153 x 146 x 42	140 x 101.6 x 25	149.6 x 146 x 42.1
<b>Material</b>	Aluminum & SPCC	Aluminum	Aluminum & SPCC	Full Metal
<b>Interface</b>	SATA 7 + 15 Pin	SATA	SATA 7 + 15 Pin	SATA III
<b>Data Transfer Rate</b>	up to 6Gb/Sec	up to 6Gb/Sec	Up to 6Gb/Sec	SATA III 6Gbps
<b>Drive Bay Space</b>	One 3.5" drive bay	One 5.25" drive bay	One 3.5" drive bay	1 x 5.25" Device Bay for 4 x 2.5" Hard Drive
<b>HDD Type</b>	2.5" SATA/SAS 2 x HDD/SSD	2.5" SATA 2 x HDD/SSD	2.5" SATA/SAS 1 x HDD/SSD	2.5" Hard Drive
<b>Cooling Fan</b>	No	Yes	No	4CM
<b>Hot Swap</b>	Yes	Yes	Yes	Yes
<b>Keylock</b>	Yes	Yes	Yes	Yes
<b>Signal Out</b>	SATA 7 Pin	SATA 7 Pin	SATA 7 Pin	SATA III 7-Pin
<b>Color</b>	Black	Black	Black	Black
<b>Gross Weight</b>	0.304 Kg	0.534 Kg	0.236 Kg	0.56kg

## FCD-301



Pin 1	Pin 2	Pin 3	Pin 4
+5V	Data-	Data+	GND

3.5" compact drive bay with USB port

- The most suitable USB cable for IEI's CPU boards
- Support standard 3.5" drive bay, 4-pin female connector to CPU boards' pin header, length: 60cm
- RoHS compliant
- Pin definition

### Ordering Information

Part No.	Description
FCD-301[C]-RS	3.5" compact drive bay with USB port, RoHS Color Code: B=Black, W=White

## AS-35A



- Resistant to shocks and vibrations from all directions
- Support 3.5" HDD into 5.25" drive bay (AS-35A)
- Meets the following standards:
  - » MIL-SLD-810F 514.5C-1 standard
  - » 5-20Hz, 1G peak to peak
  - » 60-200Hz, 3G peak to peak
- RoHS compliant

### Ordering Information

Part No.	Description
AS-35A-RS	3.5" drive anti-vibration kit, RoHS

## AS-25A





- Resistant to shocks and vibrations from all directions
- Support 2.5" HDD into 3.5" drive bay (AS-25A)
- Meets the following standards:
  - » MIL-SLD-810F 514.5C-1 standard
  - » 5-20Hz, 1G peak to peak
  - » 60-200Hz, 3G peak to peak
- RoHS compliant



### Ordering Information

Part No.	Description
AS-25A-RS	2.5" drive anti-vibration kit, RoHS

## Cables and Connectors *HDMI / SATA HDD / Serial Cable*



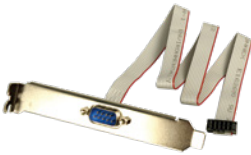

	HDMI Cable	SATA HDD Cable	
			
<b>Model Name</b>	<b>19B00-000403-00-RS</b>	<b>32801-000703-500-RS</b>	<b>32102-000100-200-RS</b>
Cable Type	HDMI Cable	SATA HDD cable	SATA power cable
Connector	HDMI 90°	SATA 7-pin	4-pin + two 15-pin
Connector Type	HDMI	Lockable	SATA power connector
Length	35 cm	50 cm	15 cm

	SATA HDD Cable		
			
<b>Model Name</b>	<b>32801-000201-300-RS</b>	<b>32801-000100-300-RS</b>	<b>32801-003706-100-RS</b>
Cable Type	SATA + Power cable	SATA + Power cable	SATA + Power cable
Connector	SATA 7-pin + 2-pin wafer (P=2 mm)	SATA 7-pin + 4-pin wafer (P=2.54 mm)	SATA 7-pin + 4-pin
Connector Type	2-pin PH 2.0	4-pin PH 2.54 mm	
Length	SATA cable 15 cm Power cable 15 cm	SATA cable 20 cm Power cable 20 cm	SATA cable 20 cm Power cable 10 cm



	Serial cable		
			
<b>Model Name</b>	<b>19800-000300-100-RS</b>	<b>19800-010900-200-RS</b>	<b>19800-020100-100-RS</b>
Cable Type	Serial port cable	Serial port cable	Serial port cable
Board Side	10-pin (2x5) connector	10-pin (2x5) connector	2 x 10-pin (2x5) connector
Board Side Pitch	2.0 mm	2.54 mm	2.54 mm
Device Side	DE9M	DE9M	DE9M
Bracket	Yes	Yes	Yes
Length	30 cm	50 cm	23 cm

Part numbers listed in the product catalog are for reference purposes. IEI reserves the right to implement substitution parts when the function is not affected.

## Cables and Connectors *Paralle / Serial Cable*

	Serial cable			
				
<b>Model Name</b>	<b>19800-003600-200-RS</b>	<b>19800-000200-100-RS</b>	<b>32205-000702-200-RS</b>	<b>32205-002700-200-RS</b>
Cable Type	Serial port cable	Serial port cable	Serial port cable	Serial port cable
Board Side	2 x 10-pin (2x5) connector	2 x 10-pin (2x5) connector	10-pin (2x5) connector	10-pin (2x5) connector
Board Side Pitch	2.54 mm	2.0 mm	2.54 mm	2.0 mm
Device Side	2 x DE9M	2 x DE9M	DE9M	DE9M
Bracket	Yes	Yes	No	No
Length	40 cm	30 cm	23 cm	20 cm

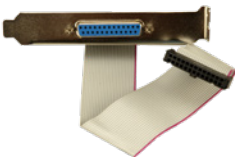

	Serial cable			
				 <b>New</b>
<b>Model Name</b>	<b>32205-001203-200-RS</b>	<b>19800-026400-100-RS</b>	<b>32205-003800-300-RS</b>	<b>32005-003500-200-RS</b>
Cable Type	Serial port cable	RS-232 & RS-422/485 cable	RS-422/485 cable	RS-232/422/485 cable
Board Side	40-pin (2x20) connector	14-pin (2x7) connector	4-pin (1x4) connector	1x 9pin (1x9) connector
Board Side Pitch	2.54 mm	2.0 mm	2.0 mm	1.25 mm
Device Side	4 x DE9M	2 x DE9M	DE9M	DE9M
Bracket	No	Yes	No	No
Length	40/40/40/40 cm	25 cm	20 cm	25 cm





	Paralle cable	
		
<b>Model Name</b>	<b>19800-000049-RS</b>	<b>32223-000700-100-RS</b>
Cable Type	Parallel port cable	Parallel port cable
Board Side	26-pin (2x13) connector	26-pin (2x13) connector
Board Side Pitch	2.54 mm	2.0 mm
Device Side	DB25F	DB25F
Bracket	Yes	No
Length	24 cm	28 cm





Part numbers listed in the product catalog are for reference purposes. IEI reserves the right to implement substitution parts when the function is not affected.



# Cables and Connectors *USB / Power Cable / Keyboard / Mouse Cable*

	USB cable		
			
<b>Model Name</b>	<b>32001-010800-200-RS</b>	<b>19800-000100-100-RS</b>	<b>CB-USB02-RS</b>
Cable type	USB cable	USB cable	USB cable
Board side	2 x 4-pin connector	2 x 8-pin (2x4) connector	2 x 4-pin (1x4) connector
Board side pitch	2.54 mm	2.54 mm	2.54 mm
Device side	2 x USB	4 x USB	2 x USB
Bracket	No	Yes	Yes
Length	20 cm	30 cm	30 cm

	USB cable			
				
<b>Model Name</b>	<b>CB-USB02A-RS</b>	<b>32001-002700-100-RS</b>	<b>32001-008600-200-RS</b>	<b>19800-010500-200-RS</b>
Cable type	USB cable	USB cable	USB cable	USB 3.0 Front Panel cable
Board side	1 x 8-pin (2x4) connector	1 x 8-pin (2x4) connector	1 x 8-pin (2x4) connector	1 x 20-pin (2x10) connector
Board side pitch	2.0 mm	2.54 mm	2.0 mm	2.0 mm
Device side	2 x USB	2 x USB	2 x USB	2 x USB
Bracket	Yes	No	No	Yes
Length	30 cm	21 cm	21 cm	45 cm

	Power cable	Keyboard / Mouse cable		
				
<b>Model Name</b>	<b>32100-087100-RS</b>	<b>19800-025700-100-RS</b>	<b>32006-000300-400-RS</b>	<b>32006-001100-201-RS</b>
Cable type	12V power cable	Y-Cable	Y-Cable	Y-Cable
Board side	1 x 4-pin (2x2) connector	1 x 6-pin (1x6) connector	1 x male PS/2	1 x 6-pin (1x6) connector
Board side pitch		2.0 mm		2.0 mm
Device side	2 x 4-pin (1x4) molex	2 x Female PS/2	2 x Female PS/2	2 x Female PS/2
Bracket	No	Yes	No	No
Length	13 cm	22 cm	12 cm (KB) + 14 (MS)	13 cm

Part numbers listed in the product catalog are for reference purposes. IEI reserves the right to implement substitution parts when the function is not affected.