

Medical Strategy of IEI Group



Providing better services from both IEI and BriteMED

IEI promises to provide our own-brand products continually as well as serving ODM vertical markets to offer complete, professional and flexible services. Learning from various medical product designs and manufacturing experiences, we found that the medical grade computer locates in a highly customized and professional product segment. For this reason, we planned to expand the market share in the medical field, and our medical business unit was then separated from the mother company to become an independent company called BriteMED on August 1st in 2009.

Population aging and technology improved day by day are the worldwide phenomenons which make the medical application become friendlier, such as healthcare digitalization (paper-less and automatic data collection), healthcare mobility and telemedicine. To provide our customers better services, we divide R&D works into two parts - by IEI and by BriteMED.



Medical IT for general healthcare



Medical Panel PC



AI Box PC



Medical Embedded Box

Medical devices for clinical use



Medical Monitor



E-Medical Cart

All-in-one Medical Grade Panel PC

Medical Certifications



User-friendly-oriented design is always the core value of us. IEI's all-in-one medical grade panel PC series offers four product lines to accommodate all healthcare needs. All products are equipped with antibacteria chassis and IP65 front bezel for easy sterilization. The integrated touchscreen can be operated whilst wearing multiple gloves. In addition, the products we designed support various communication functions, such as Bluetooth, 1D/2D barcode scanner, RFID, SCR and MSR. These panel PCs can provide convenience to clinicians and increase their work efficiency.

IASO Series

Light medical panel PC

- 10.1" Medical Panel PC
- Light bars at both side
- Remote device management
- Elkhart Lake platform



POCm2 Series

Mobile Point-of-Care Terminal

- Dual reading light
- Chemical etching AG coating
- Aluminum front bezel (IP66) & PC/ABS rear cover



POCi Series

Intelligent point-of-care terminal

- Ultra-slim front bezel
- Fanless system with high performance
- PCIe x4 expansion
- Optional DICOM preset

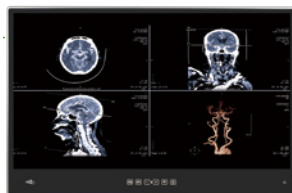

POCm Series

Mobile point-of-care terminal

- Lightweight design: under 6.8kg without battery
- Fanless system with high performance
- 3 hot-swappable batteries with battery management utility



POC Series

Point-of-care terminal

- Rich bottom I/O
- High-performance system with smart fan (or fanless)
- Ambient light sensor for panel brightness adjustment



MPOCm Series

Mobile Medical Monitor

- IP65 front bezel
- 2 variable DC outputs
- 10-point PCAP touchscreen
- Hot-swappable batteries



Selection Guide



Series		IASO
Model		IASO-W10B-N6210
LCD Specifications	LCD Size	10.1"
	Max. Resolution (W/H)	1280 x 800
	Brightness (cd/m ²)	400
	Contrast Ratio	800:1
	LCD Color	16.7M (RGB 6-bit + Hi-FRC)
	Pixel Pitch (H/V)	0.1695 x 0.1695 mm
	Viewing Angle (H/V)	178°/178°
	Backlight MTBF (hrs)	30,000 (LED backlight)
Touch	Touchscreen	Projected capacitive type with 10-point multi-touch and optical bonding
	Touch Controller	EETI
	Surface Hardness	6H
System	CPU Support	Intel® Celeron® N6210 (Elkhart Lake, 6.5W TDP)
	LAN Controller	1 x Intel® I225 Ethernet Controller
	RAM	1 x DDR4 SO-DIMM slot
	Storage	1 x M.2 2242 M key (PCIe/SATA signal)
	Audio	AMP 1W + 1W (internal speaker)
	Camera & Microphone	1 x Digital microphone
	I/O Port	1 x HDMI output 1 x Reset button 1 x Power button 1 x 12V DC jack 1 x AT/ATX switch 1 x RS-232/422/485 1 x Audio jack (TRRS) 1 x 2.5GbE supporting PoE (with 1.5kV isolation) 2 x USB 3.2 Gen 1 (5Gb/s)
	LED	2 x LED light bar
	Wi-Fi & Bluetooth	IEEE 802.11ax 2T2R module (Wi-Fi 6E) with BT v5.0 (M.2 2230 A-E key)
	Physical	Construction Material
Mounting		Wall, Stand and Arm; VESA 75/100 compliant
Weight (Net)		1.85 kg
Dimensions (LxWxH)		261 x 196.4 x 40 mm
Environment	Operating Temperature	-20°C – 40°C
	Storage Temperature	-20°C – 60°C
	Humidity	10% – 95% (non-condensing)
	Vibration	1G
	Shock	Operating shock: 5G peak acceleration (11ms duration) Non-operating shock: 15G peak acceleration (11ms duration)
	IP Level	Front: IP65
	Thermal	Fanless
Power	Power Input	12V DC input
	Power Adapter	65W medical grade power adapter
	PoE	Class 4 (IEEE802.3at) PD device w/o loading taken on I/O Class 5 (IEEE802.3bt) PD device w/ full loading taken on I/O
Certification	EMC & Safety	CE, FCC Class B Part18 IEC 60601-1: 2005+AMD1:2012 (Edition 3.1) IEC 60601-1-2: 2014 (Edition 4.0)

Selection Guide

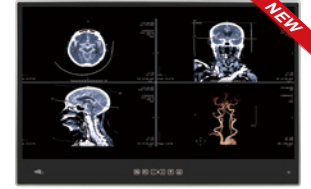
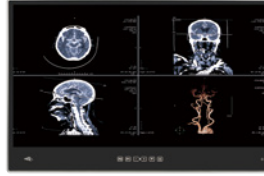

Series		POCi	
Model		POCi-W22C-ULT5	POCi-W24C-ULT5
LCD Specifications	LCD Size	21.5" (16:9)	23.8" (16:9)
	Max. Resolution (W/H)	1920 x 1080	
	Brightness (cd/m ²)	350	
	Contrast Ratio	1000:1	
	LCD Color	16.7M (RGB 6-bit + Hi-FRC)	
	Pixel Pitch (H/V)	0.24795 x 0.24795 mm	0.2745 x 0.2745 mm
	Viewing Angle (H/V)	178°/178°	
	Backlight MTBF (hrs)	30,000 (LED backlight)	
Touch	Touchscreen	Projected capacitive type with 10-point multi-touch	
	Touch Controller	EETI (80H84)	
	Surface Hardness	6H	
	Coating	Chemical AG etching	
System	CPU Support	Intel® Core™ i5-8365UE (Whiskey Lake ULT platform) Intel® Core™ i7-8665UE (Whiskey Lake ULT platform)	
	LAN Controller	1 x Intel® I211 Ethernet Controller 1 x Intel® I219 Ethernet Controller (AMT 12.x supported by i7/i5 SKUs)	
	RAM	2 x 260-pin 2400/2133MHz dual-channel DDR4 SO-DIMM, 4GB pre-installed (system max. 64GB)	
	Storage	1 x M.2 2242/60/80 M key (PCIe x4) 1 x 2.5" accessible SATA HDD/SSD bay	
	Audio	2 x 2W speaker	
	I/O Port	Bottom 1 x DC jack 1 x HDMI output 1 x Isolated 1.5kV RS-232 1 x Combo audio-out/mic-in 1 x Isolated Gigabit LAN (I211) 1 x Isolated Gigabit LAN (I219 supports Intel® vPro) 4 x USB 3.2 Gen 2 (10Gb/s) port	Side 2 x USB 2.0 port
	OSD Function	1 x Power on/off 1 x Reading light on/off 1 x Brightness up 1 x Brightness down	1 x LCD & touch lock on/off 1 x DICOM mode app on/off (optional)
	Expansion	1 x PCIe x4	
	LED	1 x RFID indicator (optional) 2 x LED reading light	
	Wi-Fi & Bluetooth	IEEE 802.11ax 2T2R module (Wi-Fi 6) with BT v5.0 (M.2 2230 A-E key)	IEEE 802.11ax 2T2R module (Wi-Fi 6E) with BT v5.0 (M.2 2230 A-E key)
	Physical	Construction Material	Front bezel: Aluminum die-casting Rear cover: ABS+PC plastic (chemical resistant)
Mounting		Wall, Stand and Arm; VESA 75/100 compliant	
Weight (Net)		6.9 kg	8.1 kg
Dimensions (LxWxH)		507.5 x 335.5 x 64.5 mm	567 x 370.6 x 63.9 mm
Environment	Operating Temperature	0°C – 40°C	
	Storage Temperature	-20°C – 60°C	
	Humidity	10% – 95% (non-condensing)	
	Vibration	1G	
	Shock	Operating shock: 5G peak acceleration (11ms duration) Non-operating shock: 15G peak acceleration (11ms duration)	
	IP Level	Front: IP66	
	Thermal	Fanless	
Power	Power Input	19V DC input	
	Power Adapter	150W medical power adapter	
	Battery	3S3P Li-ion battery pack, 11.1V, 7800mAh (optional)	
	Built-in Medical Power	150W, 85V – 264V AC, medical power supply (optional)	
Certification	EMC & Safety		
		CE, FCC Class B Part18 EN 60601-1: 2006/A1:2013 (Edition 3.1) EN 60601-1-2: 2015 (Edition 4.0)	

Selection Guide



Series		POCm2	
Model		POCm2-W22C-TGL	
LCD Specifications	LCD Size	21.5" (16:9)	
	Max. Resolution (W/H)	1920 x 1080	
	Brightness (cd/m ²)	350	
	Contrast Ratio	1000:1	
	LCD Color	16.7M (RGB 6-bit + Hi-FRC)	
	Pixel Pitch (H/V)	0.24795 x 0.24795 mm	
	Viewing Angle (H/V)	178°/178°	
Touch	Backlight MTBF (hrs)	30,000 (LED backlight)	
	Touchscreen	Projected capacitive type with 10-point multi-touch	
	Touch Controller	EETI (80H84)	
	Surface Hardness	6H	
System	Coating	Chemical AG etching	
	CPU Support	11th Gen Intel® mobile ULT(UP3) on-board processor Intel® Core™ i5-1145G7E (Tiger Lake ULT platform) Intel® Core™ i7-1185G7E (Tiger Lake ULT platform)	
	LAN Controller	2 x Intel® I225 Ethernet Controller	
	RAM	2 x SO-DIMM DDR4 3200MHz (system max. 128GB)	
	Storage	2 x M.2 2242/60/80 M key (PCIe+SATA) with RAID	
	Audio	2 x 2W speaker	
	I/O Port	Bottom 1 x DC jack 1 x HDMI output 1 x DC output (12V/19V/24V) 1 x USB Type-C (DP + USB 5V/3A) 1 x Audio jack 2 x USB 2.0 2 x 2.5GbE LAN port 4 x USB 3.2 Gen 2 (10Gb/s) port	Other 1 x Barcode scanner (optional)
System	OSD Function	1 x Power on/off 1 x Reading light on/off 1 x Brightness up 1 x Brightness down 1 x LCD & touch lock on/off 1 x Programmable button	
	Expansion	1 x PCIe Mini (PCIe) 1 x M.2 2230 A-E key (PCIe+USB) 2 x M.2 2260/80 B-M key (PCIe/SATA)	
	LED	1 x Power indicator 1 x RFID indicator 2 x Battery indicator 2 x LED reading light	
	Wi-Fi & Bluetooth	IEEE 802.11ax 2T2R module (Wi-Fi 6E) with BT v5.0 (M.2 2230 A-E key)	
Physical	Construction Material	Front bezel: Aluminum Rear cover: ABS+PC plastic (ENH2900)	
	Mounting	Wall, Stand and Arm; VESA 75/100 compliant	
	Weight (net)	Under 6.8 kg (without battery)	
	Dimensions (LxWxH)	507.5 x 335.5 x 71 mm	
Environment	Operating Temperature	0°C – 40°C	
	Storage Temperature	-20°C – 60°C	
	Humidity	10% – 95% (non-condensing)	
	Vibration	1G	
	Shock	Operating shock: 5G peak acceleration (11ms duration) Non-operating shock: 15G peak acceleration (11ms duration)	
	IP Level	Front: IP66	
	Thermal	Fanless	
Power	Power Input	19V DC input	
	Power Adapter	150W medical power adapter	
	Battery	2 slots for Li-ion battery pack	
Certification	EMC & Safety	CE, FCC Class B Part18 EN 60601-1: 2006/A1:2013 (Edition 3.1) EN 60601-1-2: 2015 (Edition 4.0)	

Selection Guide



Series		POCm		
Model		POCm-W22C-ULT3	POCm-W24C-ULT3	
LCD Specifications	LCD Size	21.5" (16:9)	23.8" (16:9)	
	Max. Resolution (W/H)	1920 x 1080		
	Brightness (cd/m ²)	250		
	Contrast Ratio	1000:1		
	LCD Color	16.7M (RGB 6-bit + Hi-FRC)		
	Pixel Pitch (H/V)	0.24825 x 0.24825 mm	0.2745 x 0.2745 mm	
	Viewing Angle (H/V)	170°/160°	178°/178°	
	Backlight MTBF (hrs)	30,000 (LED backlight)		
Touch	Touchscreen	Projected capacitive type with 10-point multi-touch		
	Touch Controller	EETI		
	Surface Hardness	6H		
System	CPU Support	6th Gen Intel® mobile ULT Core™ i7-6600U / Core™ i5-6300U / Celeron® 3855U		
	LAN Controller	1 x Intel® I211 Ethernet Controller 1 x Intel® I219 Ethernet Controller (AMT 12.x supported by i7/i5 SKUs)		
	RAM	2 x 260-pin 2400/2133MHz dual-channel DDR4 SO-DIMM, 4GB pre-installed (system max. 32GB)		
	Storage	1 x 2.5" accessible SATA HDD bay 2 x M.2 2280 M key (PCIe/SATA) with RAID		
	Audio	2 x 2W speaker		
	Camera & Microphone	5-megapixel CMOS front-facing camera with auto-focus and digital microphone		
	I/O Port	Bottom	Side	
		1 x DC jack 1 x Digital mic 2 x HDMI output 2 x GbE LAN port 2 x RS-232/422/485 4 x USB 3.2 Gen 1 (5Gb/s) port	1 x Mic in 1 x Audio out 2 x USB 2.0 port	
	OSD Function	1 x Power on/off 1 x Volume up 1 x Volume down	1 x Brightness up 1 x Brightness down 1 x LCD on/off and touch lock for cleaning	
	Expansion	1 x Full-size/Half-size PCIe Mini (PCIe+USB)		
	LED	1 x RFID indicator 1 x Power indicator 3 x Battery indicator (color: blue/red)		
	Wi-Fi & Bluetooth	IEEE 802.11a/b/g/n/ac 2T2R module with BT v4.2 (M.2 2230 A-E key)		
	Physical	Construction Material	ABS+PC plastic with anti-bacterial material	
		Mounting	Wall, Stand and Arm; VESA 75/100 compliant	
Weight (Net)		7.07 kg (without battery) 8.43 kg (with 3 batteries)	8.18 kg (without battery) 9.53 kg (with 3 batteries)	
		Dimensions (LxWxH)	543 x 350 x 71mm	594.6 x 379.6 x 71 mm
Environment	Operating Temperature	0°C – 40°C		
	Storage Temperature	-20°C – 60°C		
	Humidity	10% – 90% (non-condensing)		
	Vibration	1G		
	Shock	Operating shock: 5G peak acceleration (11ms duration) Non-operating shock: 10G peak acceleration (11ms duration)		
	IP Level	Front: IP65		
	Thermal	Fanless		
Power	Power Input	19V DC input		
	Power Adapter	150W medical power adapter		
	Battery	3 slots for Li-ion battery packs		
Certification	EMC & Safety	CE, FCC Class B Part18 IEC 60601-1: 2005+AMD1:2012 (Edition 3.1) IEC 60601-1-2: 2014 (Edition 4.0)		

Selection Guide



Series		POC	
Model		POC-17C-ULT3	POC-W24C-ULT3
LCD Specifications	LCD Size	17" (5:4)	24" (16:9)
	Max. Resolution (W / H)	1280 x 1024	1920 x 1080
	Brightness (cd/m ²)	350	250
	Contrast Ratio	1000:1	1000:1
	LCD Color	16.7M (RGB 6-bit + Hi-FRC)	16.7M (RGB 6-bit + Hi-FRC)
	Pixel Pitch (H / V)	0.264 x 0.264 mm	0.2745 x 0.2745 mm
	Viewing Angle (H / V)	170°/160°	178°/178°
	Backlight MTBF (hrs)	30,000 (LED backlight)	30,000 (LED backlight)
Touch	Touchscreen	Projected capacitive type with 10-point multi-touch	Projected capacitive type with 10-point multi-touch
	Touch Controller	EETI	EETI
	Surface Hardness	6H	6H
System	CPU Support	6th Gen Intel® mobile ULT Core™ i7-6600U / Core™ i5-6300U / Celeron® 3855U	6th Gen Intel® mobile ULT Core™ i7-6600U / Core™ i5-6300U / Celeron® 3855U 7th Gen Intel® mobile ULT Kaby Lake on-board SoC (By project base)
	RAM	2 x 260-pin 2400/2133MHz dual-channel DDR4 SO-DIMM, 4GB pre-installed (system max.32GB)	2 x 260-pin 2400/2133MHz dual-channel DDR4 SO-DIMM, 4GB pre-installed (system max. 32GB)
	Storage	1 x mSATA (E-Window) 2 x 2.5" SATA 6Gb/s accessible HDD bay with RAID 0, 1 (RAID is only supported by Core™ i5 and Core™ i7)	1 x mSATA (E-Window) 1 x 2.5" SATA 6Gb/s HDD/SDD bay
	Audio	2 x 2W speaker	2 x 3W speaker
	Camera & Microphone	2-megapixel CMOS front-facing camera with auto-focus and digital microphone	5-megapixel CMOS front-facing camera with auto-focus and digital microphone
	I/O Port	1 x HDMI output 1 x 12V – 28V DC jack 1 x RS-232/422/485 1 x RJ-11 for 1D/2D barcode reader	2 x GbE LAN port 4 x USB 3.2 Gen 1 (5Gb/s) port 4 x USB 2.0 port (2 on the side)
	OSD Function	1 x LCD on/off 1 x Volume up 1 x Volume down 1 x Brightness up 1 x Brightness down 1 x Touch lock button for cleaning	Combinations: 1 x Lock/Unlock OSD 1 x Power on/off
	Expansion	1 x E-Window slot (full-size PCIe Mini slot with PCIe/mSATA/USB)	1 x PCIe Mini reserved for E-Window expansion
	LED	1 x RFID indicator	1 x RFID indicator
	Wi-Fi & Bluetooth	IEEE 802.11a/b/g/n/ac 2T2R module with BT V4.1 (M.2 2230 A-E key)	IEEE 802.11a/b/g/n/ac 2T2R module with BT v4.1 (M.2 2230 A-E key)
Other Features	Auto-dimming	Yes	Yes
	Light Sensor	-	Ambient light sensor for panel brightness adjustment
Physical	Construction Material	ABS+PC plastic with anti-bacterial material	ABS+PC plastic with anti-bacterial material
	Mounting	Wall, Stand and Arm; VESA 75/100 compliant	Wall, Stand and Arm; VESA 75/100 compliant
	Weight (Net)	6.0 kg	7.5 kg
	Dimensions (LxWxH)	435 x 376 x 64.5 mm	594.6 x 379.6 x 60.68 mm
Environment	Operating Temperature	0°C – 40°C	0°C – 40°C
	Storage Temperature	-20°C – 65°C	-20°C – 60°C
	Humidity	10% – 95% (non-condensing)	10% – 95% (non-condensing)
	Vibration	1G	1G
	Shock	Operating shock: 5G peak acceleration (11ms duration) Non-operating shock: 15G peak acceleration (11ms duration)	Operating shock: 5G peak acceleration (11ms duration) Non-operating shock: 15G peak acceleration (11ms duration)
	IP Level	Front: IP65	Front: IP65
	Thermal	Fanless	Fanless
Power	Power Input	19V DC input	19V DC input
	Power Adapter	150W medical power adapter	150W medical power adapter
Certification	EMC & Safety	CE, FCC Class B Part18 IEC 60601-1: 2005+AMD1: 2012 (Edition 3.1) IEC 60601-1-2: 2014 (Edition 4.0)	CE, FCC Class B Part18 IEC 60601-1: 2005+AMD1: 2012 (Edition 3.1) IEC 60601-1-2: 2014 (Edition 4.0)

NEW

Medical Panel PC

IASO-W10B-N6210 | 10.1" medical panel PC with Intel® Elkhart Lake platform

Features

- Intel® Celeron® Processor N6210
- Programmable LED light bar on both side
- 10-point PCAP touch with optical bonding
- IEEE 802.3 PoE (optional)
- RFID (NFC) reader (optional)



» Medical Data Acquisition

IEI helps to combine the data obtained at home with the medical records at the hospital so that medical personnels can observe the patient's measurement information thoroughly. The data can also be digitalized to effectively help data integration and tracking. In addition to synchronizing with the data in the hospital, if the patient is hospitalized, the data can also be saved in the system. These data can be kept intact and effectively used as an evaluation basis for diagnosis and treatment.

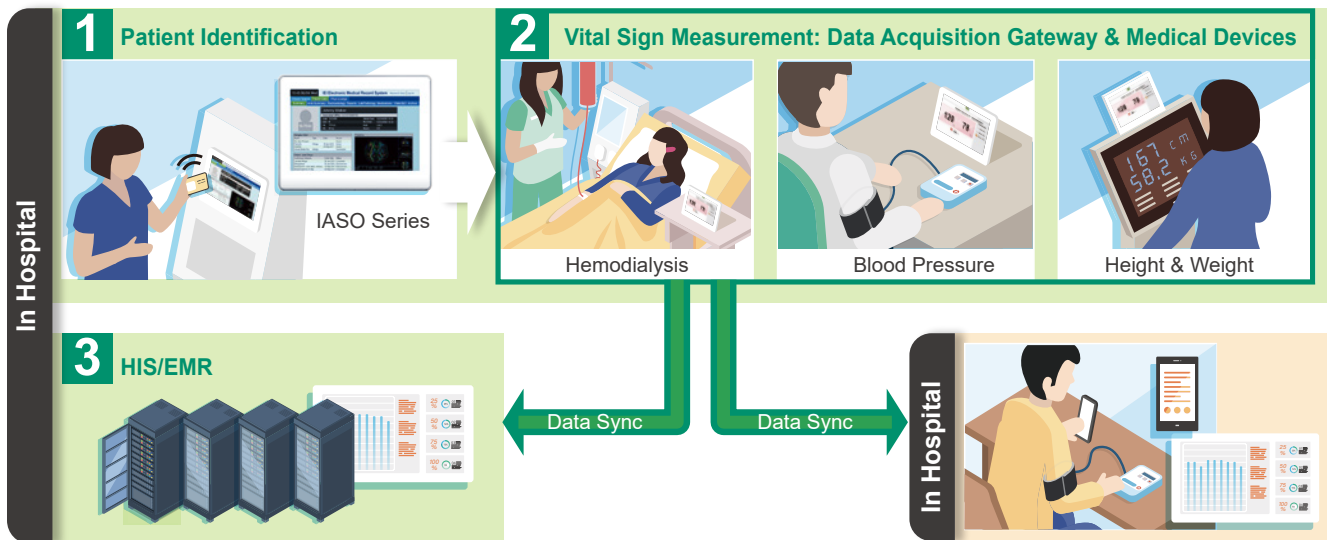

» Usage Scenarios



Patient Card



Patient Card



Medical Data Acquisition

Specifications

Model		IASO-W10B-N6210
LCD Specifications	LCD Size	10.1"
	Max. Resolution (W/H)	1280 x 800
	Brightness (cd/m ²)	400
	Contrast Ratio	800:1
	LCD Color	16.7M (RGB 6-bit + Hi-FRC)
	Pixel Pitch (H/V)	0.1695 x 0.1695 mm
	Viewing Angle (H/V)	178°/178°
	Backlight MTBF (hrs)	30,000 (LED backlight)
Touch	Touchscreen	Projected capacitive type with 10-point multi-touch and optical bonding
	Touch Controller	EETI
	Surface Hardness	6H
System	CPU Support	Intel® Celeron® N6210 (Elkhart Lake, 6.5W TDP)
	LAN Controller	1 x Intel® I225 Ethernet Controller
	RAM	1 x DDR4 SO-DIMM slot
	Storage	1 x M.2 2242 M key (PCIe/SATA signal)
	Audio	AMP 1W + 1W (internal speaker)
	Camera & Microphone	1 x Digital microphone
	I/O Port	1 x HDMI output 1 x Reset button 1 x Power button 1 x 12V DC jack 1 x AT/ATX switch 1 x RS-232/422/485 1 x Audio jack (TRRS) 1 x 2.5GbE supporting PoE (with 1.5kV isolation) 2 x USB 3.2 Gen 1 (5Gb/s)
	LED	2 x LED light bar
	Wi-Fi & Bluetooth	IEEE 802.11ax 2T2R module (Wi-Fi 6E) with BT v5.0 (M.2 2230 A-E key)
	Physical	Construction Material
Mounting		Wall, Stand and Arm; VESA 75/100 compliant
Weight (Net)		1.85 kg
Dimensions (LxWxH)		261 x 196.4 x 40 mm
Environment	Operating Temperature	-20°C – 40°C
	Storage Temperature	-20°C – 60°C
	Humidity	10% – 95% (non-condensing)
	Vibration	1G
	Shock	Operating shock: 5G peak acceleration (11ms duration) Non-operating shock: 15G peak acceleration (11ms duration)
	IP Level	Front: IP65
	Thermal	Fanless
Power	Power Input	12V DC input
	Power Adapter	65W medical grade power adapter
	PoE	Class 4 (IEEE802.3at) PD device w/o loading taken on I/O Class 5 (IEEE802.3bt) PD device w/ full loading taken on I/O
Certification	EMC & Safety	CE, FCC Class B Part18 IEC 60601-1: 2005+AMD1:2012 (Edition 3.1) IEC 60601-1-2: 2014 (Edition 4.0)

Ordering Information

Part No.	Description
IASO-W10B-N6210/4G-R10	10.1" 400cd/m ² medical panel PC with Intel® Celeron® N6210 (Elkhart Lake, 6.5W TDP), one 4GB DDR4 RAM, Wi-Fi 6E module, PCAP touchscreen
IASO-W10B-N6210/4G/PoE-R10 *	10.1" 400cd/m ² medical panel PC with Intel® Celeron® N6210 (Elkhart Lake, 6.5W TDP), one 4GB DDR4 RAM, Wi-Fi 6E module, PCAP touchscreen, IEEE802.3 PoE

* By order production

Options

Item	Part No.	Description
RFID	27765-000002-RS	RFID module (integrated RFID reader, RF Ideas KT-805N24KU-F01009, USB 2.0, 13.56MHz/125KHz, CCL, RoHS)

IQ Mounting Options

Item	Part No.	Description
In-wall Mounting Kit	IASOWK-10B	In-wall mounting kit with lock for IASO-W10B-N6210, RoHS *In-wall mounting kit is not recommended for use in a fully sealed space.

Packing List

Item	Q'ty	Remark
Power Adapter	1	65W medical power adapter
Power Cord	1	European power cord, 183 cm, C13

I/O Interface

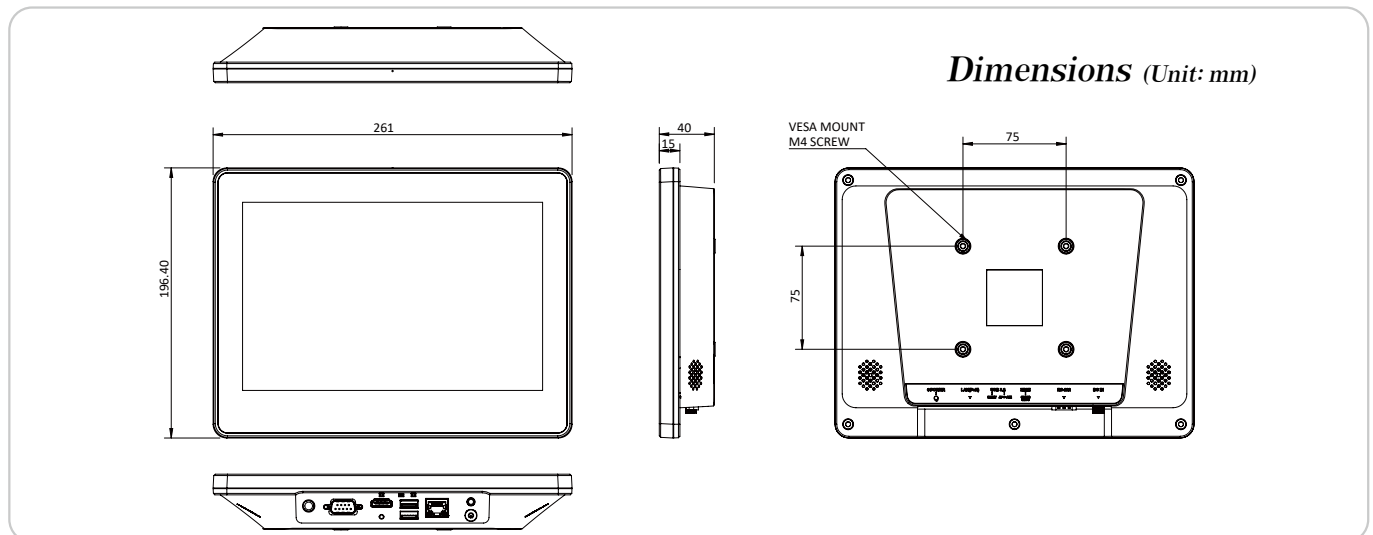
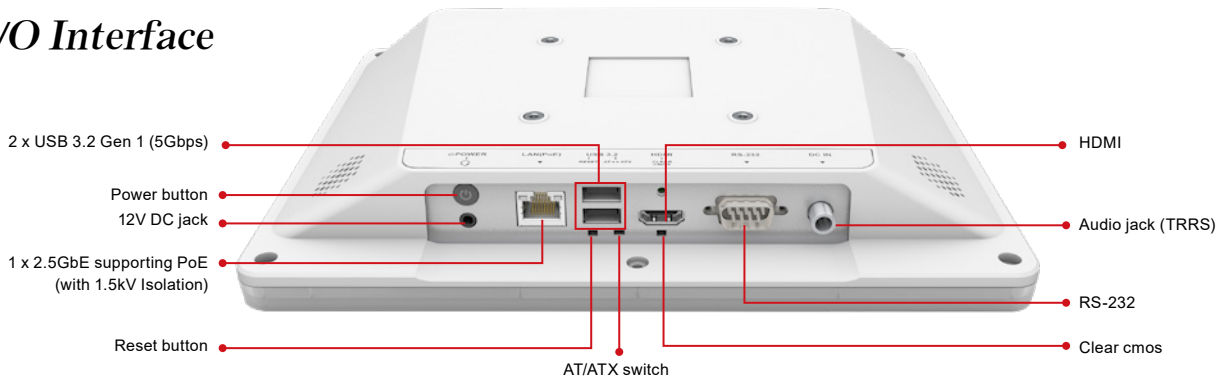

Intelligent Point-of-Care Terminal

NEW

POCi-W22C-ULT5
POCi-W24C-ULT5

22" / 24" Medical Panel PC with 8th Generation Intel® mobile ULT Core™ i7/i5 processor

Features

- Dual reading light
- Chemical etching AG coating
- Modular PCIe x4 expansion slot
- Aluminum front bezel (IP66) & PC/ABS rear cover
- FHD IPS panel with optional DICOM preset module
- 14nm 8th generation Intel® Whiskey Lake U platform

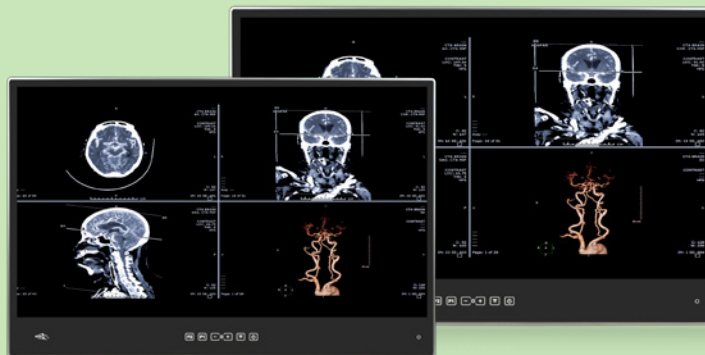

• Intelligent Working Station

The POCi series is a medical panel PC featuring AI, edge computing with rich expansion functions. It is ideal to work in many kinds of medical scenario such as radiology, telemedicine, endoscopy system or surgical working station.

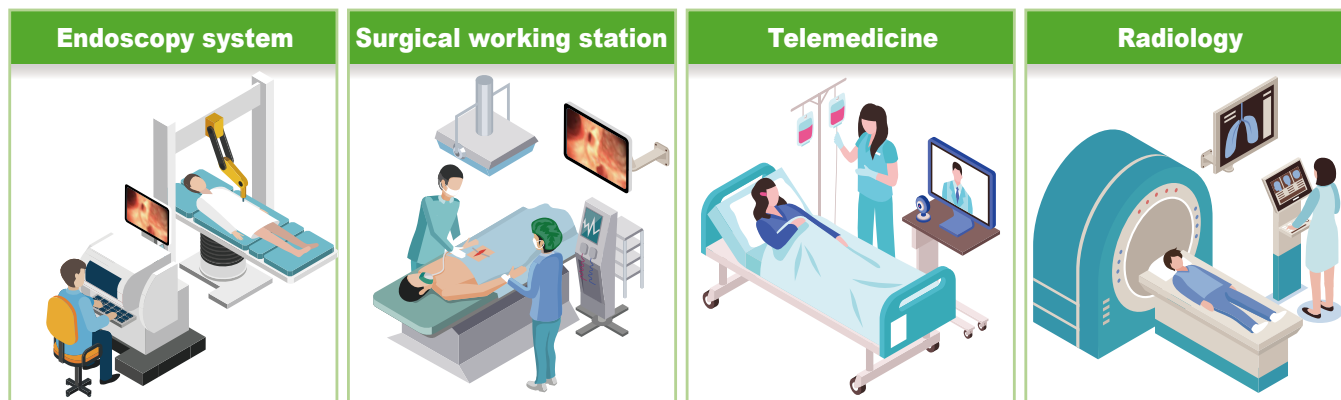

• IPS Panel with Chemical Etching AG Coating Glass

High-performance IPS panel enables a wider 178° viewing angles and advanced visual performance. The chemical etching AG coating reduces the watching fatigue resulting from glare or any other light interference in different kinds of environments.

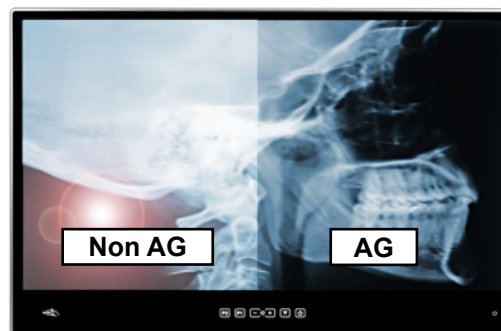
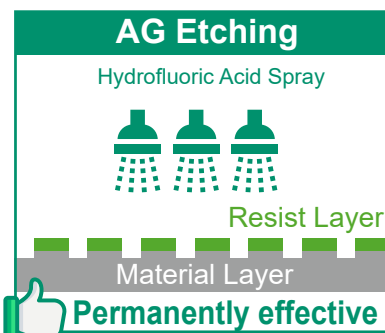
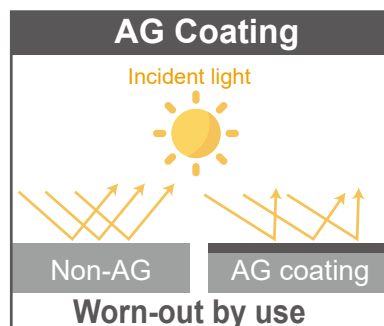

» Intelligent Point of Care Terminal

● Ultra-slim Aluminum Front Bezel

The ultra-slim front bezel creates a premium user experience. This design lets the medical personnel more focus on the clinical information displayed on the screen.



● Optional DICOM Preset

The way the human eye responds to contrasts in light levels is not linear. At low levels, we can notice small changes in luminance. At higher luminance, the change needs to be much greater before we perceive the difference from one level to the next. Calibration of the display system is important to ensure that each image is shown consistently every time it is viewed.



● Dual Reading Lights

The IEC 62471 compliant LEDs assure the reading light emits comfortable and safe light for human eyes. Easy adjustable dimming interface allows the user to choose the best brightness in different situations.



● Isolated I/O Ports

These 1.5kV isolated COM & LAN ports are compliant to the MOOP classification and use UL94 V-0 Flammability Standard Mylar® sheet insulation.



● ESD Protection

IEI provides Electrostatic discharge (ESD) 15kV (air) and 8kV (contact) ESD Protection. It can protect the circuit of a device from an Electrostatic discharge (ESD), in order to prevent malfunction of device.

● Chemical Resistance for Easy Sterilization

Sterilization is a daily routine of hospitals. Aluminum front frame is not only lightweight but also very durable for chemical erosion. The PC/ABS back cover is also carefully selected and proved to be resistant to the commonly seen detergents.



● IP Protection

IP66 front bezel and cover are easy to be cleaned with cleaners.

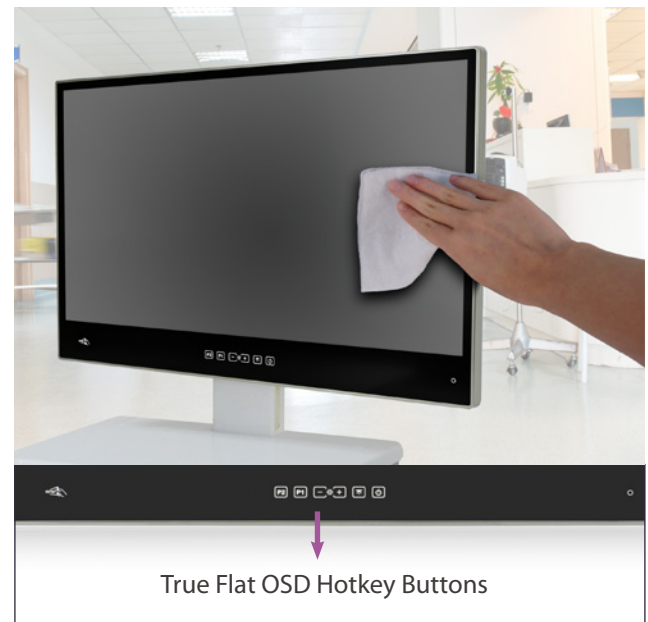

● True Flat OSD Hotkey Buttons

True flat OSD button design with no inaccessible corner brings conveniences for the cleaning personnel and increases cleaning efficiency.

● Wi-Fi 6 Module

The POCi-W22/24C-ULT5 supports the latest Wi-Fi 6 standard which enables more clients in dense environments and will provide a better experience for typical wireless LAN networks.

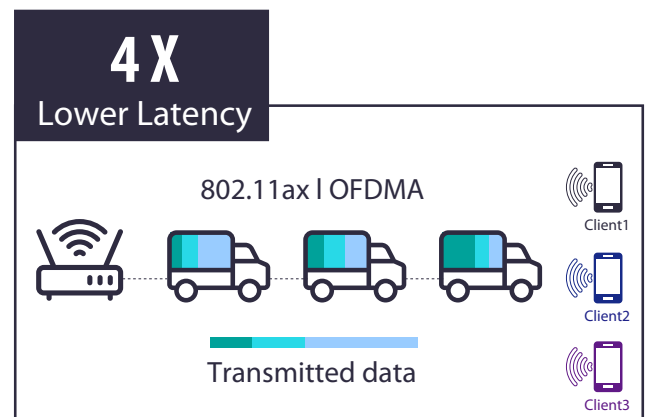
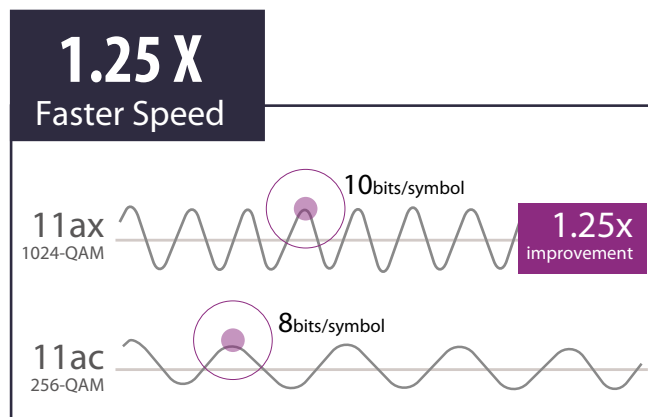
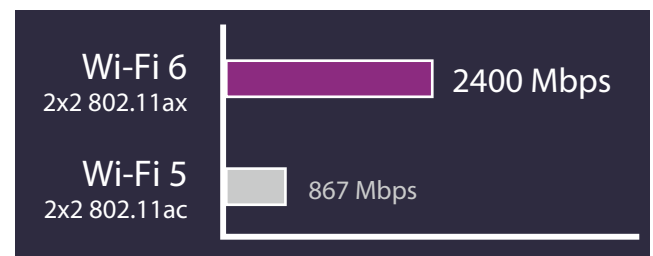

● Storage Device

The POCi-W22C-ULT5 provides flexible options for storage

- 2.5" HDD/SSD
- M.2 M key slot for NVMe, up to PCIe 3.0 x4

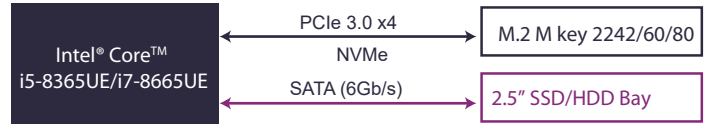

Interface	Bandwidth	
M.2 SATA 6Gb/s	Mainstream	6Gb/s
M.2 PCIe 2.0 x2		1.0GB/s
M.2 PCIe 3.0 x4		3.94GB/s

● Accessible HDD Cover & Cable Cover

Users can easily manage all the cables from the I/O ports, preventing splash to IO ports or messy cabling. Accessible HDD cover makes the IT maintenance job more efficient.

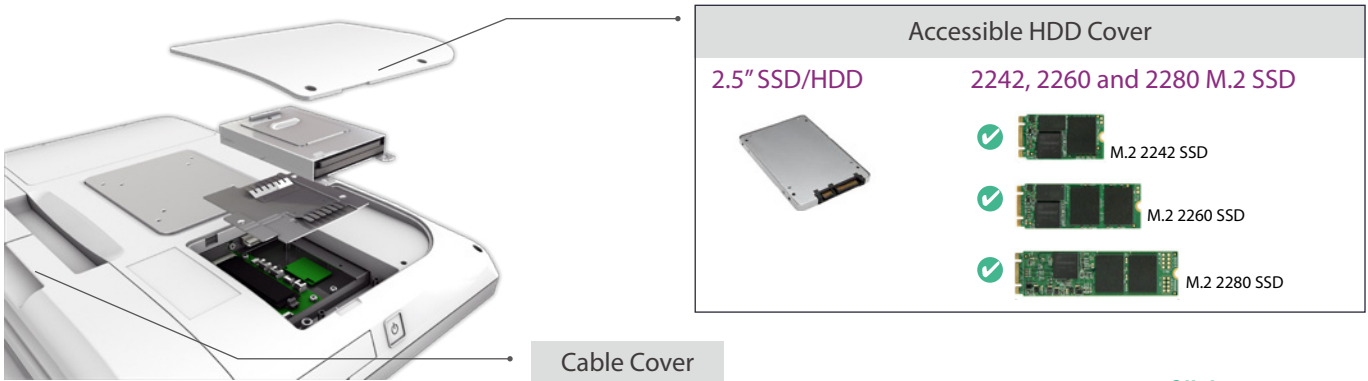

● Click-to-fix M.2 Slot

Special click-to-fix plunger design makes the M.2 replacing work much more convenient and prompt.

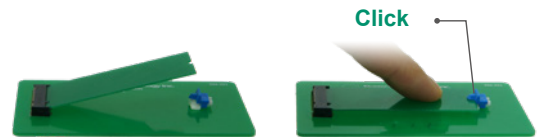

● Modular Expansion Design

The highly expandable PCIe x4 slot makes the whole system more flexible and easily meet the individual needs from different applications. For instance, adopting the AI accelerator card to enhance computing power, adding an all-in-one capture card to connect with medical devices, integrating PoE injector card with webcam, or expanding the desired I/O card for multiple usage.

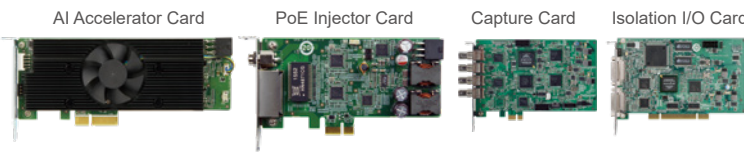

● Optional Built-in Battery

Uninterruptible Power System (UPS) is widely used in medical industry for securing patient's safety. The lateral expansion slot is available for a built-in battery which provides emergency power for 60 mins when the input source or main power fails under unexpected events.

* This feature needs to be requested before product shipment only and it will interfere with the lateral PCIe x4 expansion slot.

● Optional Built-in Power

To implement the built-in medical-grade power supply system, simply connect the power cord to the system without the use of an external power adapter.

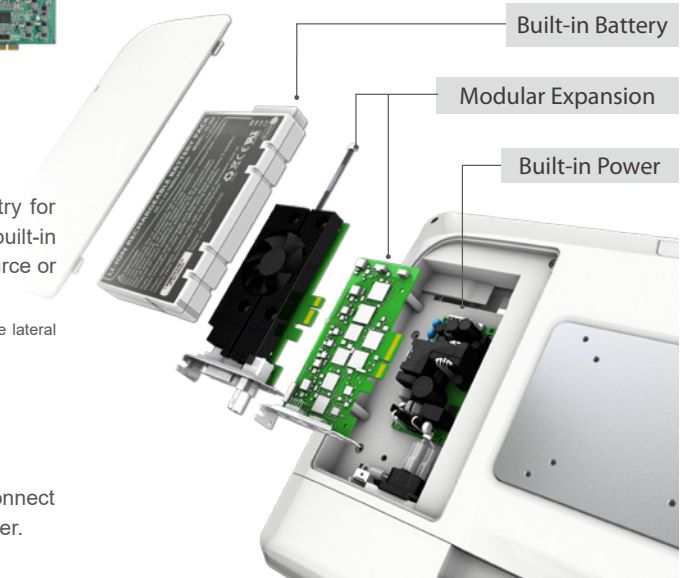

Specifications

Model	POCi-W22C-ULT5	POCi-W24C-ULT5		
LCD Specifications	LCD Size	21.5" (16:9)	23.8" (16:9)	
	Max. Resolution (W/H)	1920 x 1080		
	Brightness (cd/m ²)	350		
	Contrast Ratio	1000:1		
	LCD Color	16.7M (RGB 6-bit + Hi-FRC)		
	Pixel Pitch (H/V)	0.24795 x 0.24795 mm	0.2745 x 0.2745 mm	
	Viewing Angle (H/V)	178°/178°		
	Backlight MTBF (hrs)	30,000 (LED backlight)		
Touch	Touchscreen	Projected capacitive type with 10-point multi-touch		
	Touch Controller	EETI (80H84)		
	Surface Hardness	6H		
	Coating	Chemical AG etching		
System	CPU Support	Intel® Core™ i5-8365UE (Whiskey Lake ULT platform) Intel® Core™ i7-8665UE (Whiskey Lake ULT platform)		
	LAN Controller	1 x Intel® I211 Ethernet Controller 1 x Intel® I219 Ethernet Controller (AMT 12.x supported by i7/i5 SKUs)		
	RAM	2 x 260-pin 2400/2133MHz dual-channel DDR4 SO-DIMM, 4GB pre-installed (system max. 64GB)		
	Storage	1 x M.2 2242/60/80 M key (PCIe x4) 1 x 2.5" accessible SATA HDD/SSD bay		
	Audio	2 x 2W speaker		
	I/O Port	Bottom 1 x DC jack 1 x HDMI output 1 x Isolated 1.5kV RS-232 1 x Combo audio-out/mic-in 1 x Isolated Gigabit LAN (I211) 1 x Isolated Gigabit LAN (I219 supports Intel® vPro) 4 x USB 3.2 Gen 2 (10Gb/s) port	Side 2 x USB 2.0 port	
	OSD Function	1 x Power on/off 1 x Reading light on/off 1 x Brightness up 1 x Brightness down	1 x LCD & touch lock on/off 1 x DICOM mode app on/off (optional)	
	Expansion	1 x PCIe x4		
	LED	1 x RFID indicator (optional) 2 x LED reading light		
	Wi-Fi & Bluetooth	IEEE 802.11ax 2T2R module (Wi-Fi 6) with BT v5.0 (M.2 2230 A-E key)	IEEE 802.11ax 2T2R module (Wi-Fi 6E) with BT v5.0 (M.2 2230 A-E key)	
	Physical	Construction Material	Front bezel: Aluminum die-casting Rear cover: ABS+PC plastic (chemical resistant)	
		Mounting	Wall, Stand and Arm; VESA 75/100 compliant	
		Weight (Net)	6.9 kg	8.1 kg
Dimensions (LxWxH)		507.5 x 335.5 x 64.5 mm	567 x 370.6 x 63.9 mm	
Environment	Operating Temperature	0°C – 40°C		
	Storage Temperature	-20°C – 60°C		
	Humidity	10% – 95% (non-condensing)		
	Vibration	1G		
	Shock	Operating shock: 5G peak acceleration (11ms duration) Non-operating shock: 15G peak acceleration (11ms duration)		
	IP Level	Front: IP66		
	Thermal	Fanless		
Power	Power Input	19V DC input		
	Power Adapter	150W medical power adapter		
	Battery	3S3P Li-ion battery pack, 11.1V, 7800mAh (optional)		
	Built-in Medical Power	150W, 85V – 264V AC, medical power supply (optional)		
Certification	CE, FCC Class B Part18 EN 60601-1: 2006/A1:2013 (Edition 3.1) EN 60601-1-2: 2015 (Edition 4.0)			

Ordering Information

Part No.	Description	
22"	POCi-W22C-ULT5-i5/PC/4G-R10	21.5" 350cd/m ² FHD medical panel PC with 8th generation 14nm Intel® mobile Core™ i5-8365UE (15W) 1.6GHz on-board processor (ULT), one 4GB DDR4 RAM, 802.11ax Wi-Fi module, PCAP touchscreen w/ AG coating, microphone, R10
	POCi-W22C-ULT5-i5/PC/4G-B-R10 *	21.5" 350cd/m ² FHD medical panel PC with 8th generation 14nm Intel® mobile Core™ i5-8365UE (15W) 1.6GHz on-board processor (ULT), one 4GB DDR4 RAM, 802.11 ax Wi-Fi module, PCAP touchscreen w/ AG coating, microphone, w/ battery , R10
	POCi-W22C-ULT5-i5/PC/4G-BP-R10 *	21.5" 350cd/m ² FHD medical panel PC with 8th generation 14nm Intel® mobile Core™ i5-8365UE (15W) 1.6GHz on-board processor (ULT), one 4GB DDR4 RAM, 802.11 ax Wi-Fi module, PCAP touchscreen w/ AG coating, microphone, w/ built-in power , R10
	POCi-W22C-ULT5-i7/PC/4G-R10 *	21.5" 350cd/m ² FHD medical panel PC with 8th generation 14nm Intel® mobile Core™ i7-8665UE (15W) 1.7GHz on-board processor (ULT), one 4GB DDR4 RAM, 802.11 ax Wi-Fi module, PCAP touchscreen w/ AG coating, microphone, R10
	POCi-W22C-ULT5-i7/PC/4G-B-R10 *	21.5" 350cd/m ² FHD medical panel PC with 8th generation 14nm Intel® mobile Core™ i7-8665UE (15W) 1.7GHz on-board processor (ULT), one 4GB DDR4 RAM, 802.11 ax Wi-Fi module, PCAP touchscreen w/ AG coating, microphone, w/ battery , R10
	POCi-W22C-ULT5-i7/PC/4G-BP-R10 *	21.5" 350cd/m ² FHD medical panel PC with 8th generation 14nm Intel® mobile Core™ i7-8665UE (15W) 1.7GHz on-board processor (ULT), one 4GB DDR4 RAM, 802.11 ax Wi-Fi module, PCAP touchscreen w/ AG coating, microphone, w/ built-in power , R10
24"	POCi-W24C-ULT5-i5/PC/4G-R10	23.8" 350cd/m ² FHD medical panel PC with 8th generation 14nm Intel® mobile Core™ i5-8365UE (15W) 1.6GHz on-board processor (ULT), one 4GB DDR4 RAM, 802.11 ax Wi-Fi module, PCAP touchscreen w/ AG coating, microphone, R10
	POCi-W24C-ULT5-i5/PC/4G-B-R10 *	23.8" 350cd/m ² FHD medical panel PC with 8th generation 14nm Intel® mobile Core™ i5-8365UE (15W) 1.6GHz on-board processor (ULT), one 4GB DDR4 RAM, 802.11 ax Wi-Fi module, PCAP touchscreen w/ AG coating, microphone, w/ battery , R10
	POCi-W24C-ULT5-i5/PC/4G-BP-R10 *	23.8" 350cd/m ² FHD medical panel PC with 8th generation 14nm Intel® mobile Core™ i5-8365UE (15W) 1.6GHz on-board processor (ULT), one 4GB DDR4 RAM, 802.11 ax Wi-Fi module, PCAP touchscreen w/ AG coating, microphone, w/ built-in power , R10
	POCi-W24C-ULT5-i7/PC/4G-R10 *	23.8" 350cd/m ² FHD medical panel PC with 8th generation 14nm Intel® mobile Core™ i7-8665UE (15W) 1.7GHz on-board processor (ULT), one 4GB DDR4 RAM, 802.11 ax Wi-Fi module, PCAP touchscreen w/ AG coating, microphone, R10
	POCi-W24C-ULT5-i7/PC/4G-B-R10 *	23.8" 350cd/m ² FHD medical panel PC with 8th generation 14nm Intel® mobile Core™ i7-8665UE (15W) 1.7GHz on-board processor (ULT), one 4GB DDR4 RAM, 802.11 ax Wi-Fi module, PCAP touchscreen w/ AG coating, microphone, w/ battery , R10
	POCi-W24C-ULT5-i7/PC/4G-BP-R10 *	23.8" 350cd/m ² FHD medical panel PC with 8th generation 14nm Intel® mobile Core™ i7-8665UE (15W) 1.7GHz on-board processor (ULT), one 4GB DDR4 RAM, 802.11 ax Wi-Fi module, PCAP touchscreen w/ AG coating, microphone, w/ built-in power , R10

* By order production

Options

Item	Part No.	Description
RFID1	19B00-000430-00-RS	Mifare RFID reader for POCi-W22C-ULT5, 13.56MHz, Z641, RFID board + antenna, IEI assembly only
	19B00-000426-00-RS	Mifare RFID reader for POCi-W24C-ULT5, 13.56MHz, Z686, RFID board + antenna, IEI assembly only
RFID2	19B00-000425-00-RS	RFID reader for POCi-W22C-ULT5, 125KHz, IEI assembly only
RFID3	19XS0Z686-0006001-000-RS	RFID reader for POCi-W24C-ULT5, 13.56MHz and 125KHz dual band, IEI assembly only
DICOM	19B00-000431-00-RS	DICOM board module for POCi-W22C-ULT5, IEI assembly only
	19B00-000427-00-RS	DICOM board module for POCi-W24C-ULT5, IEI assembly only
TPM	TPM-IN03-R10	20-pin Infineon SPI TPM 2.0 module, software management tool, firmware V7.63
OS Image	POCi-W22C-W10E64-V-R10	OS image with Windows Embedded Standard 10 E Value 64-bit 2019 for POCi-W22C/W24C Series
Cable Cover	43106-4327K8-00-RS	Cable cover for POCi-W22C, white, plastic, R10, IEI assembly only
	43106-4335K8-00-HF	Cable cover for POCi-W24C, white, plastic, R10, IEI assembly only
Battery	31603-000069-RS	3S3P Li-ion battery pack, 11.1V, 7800mAh, ATO only, CCL, RoHS

IQ Mounting Options

Item	Part No.
Stand	STAND-A21-R10 (black)
	STAND-A21W-R10 (white)

Packing List

Item	Q'ty	Remark
Power Adapter	1	150W medical power adapter
Power Cord	1	European power cord, 183 cm, C13

POCi-W22C-ULT5 / POCi-W24C-ULT5
I/O Interface

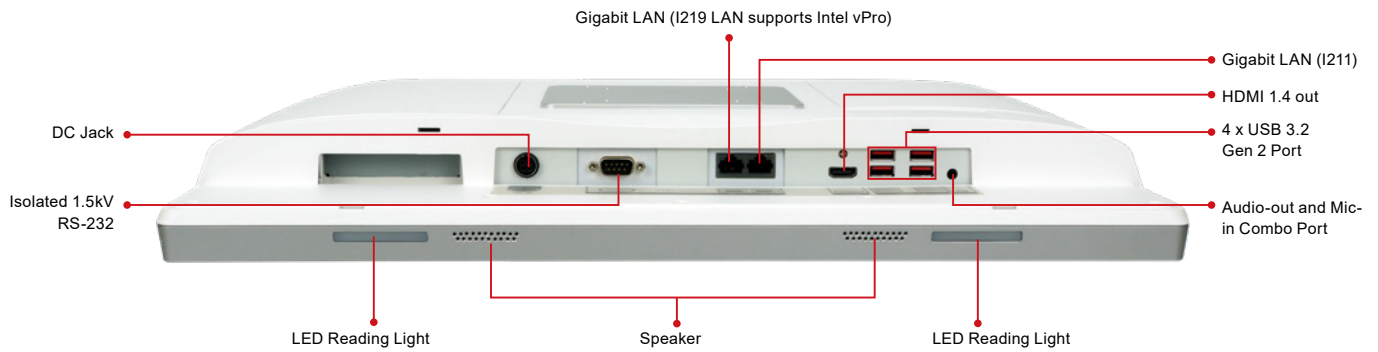

POCi-W22C-ULT5
Dimensions (Unit: mm)

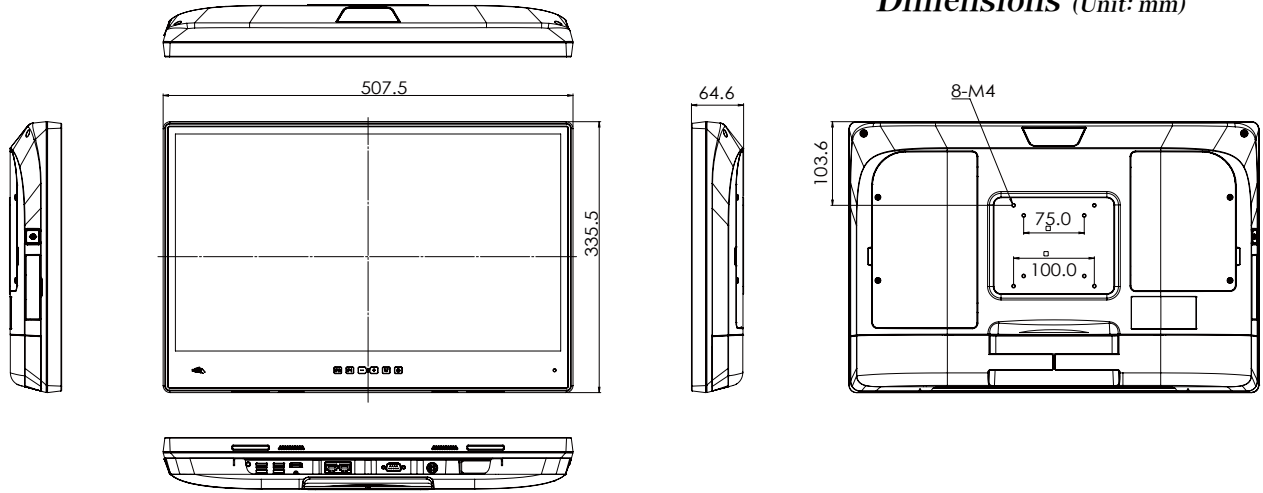

POCi-W24C-ULT5
Dimensions (Unit: mm)

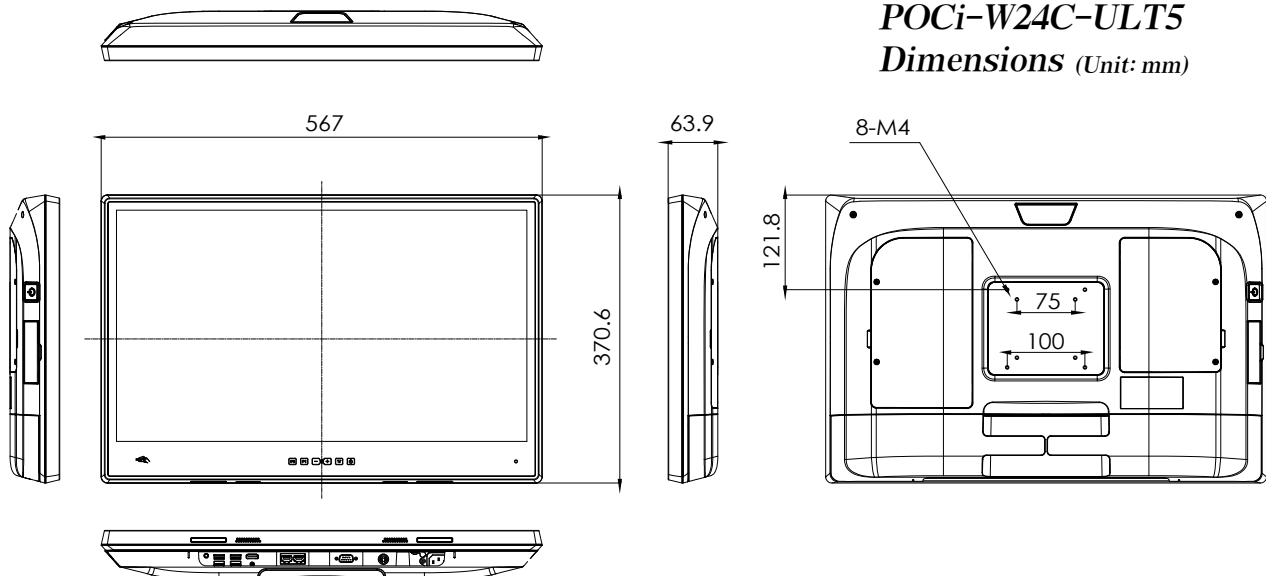

NEW

Mobile Point-of-Care Terminal

POCm2-W22C-TGL | 22" Medical Panel PC with 11th Gen Intel® mobile ULT(UP3) Core™ i7/i5 processor

Features

- Dual reading light
- Chemical etching AG coating
- Aluminum front bezel (IP66) & PC/ABS rear cover
- Two hot-swappable batteries with a total runtime of 8 hours, ideal for non-powered medical carts



Specifications

Model	POCm2-W22C-TGL		
LCD Specifications	LCD Size	21.5" (16:9)	
	Max. Resolution (W/H)	1920 x 1080	
	Brightness (cd/m²)	350	
	Contrast Ratio	1000:1	
	LCD Color	16.7M (RGB 6-bit + Hi-FRC)	
	Pixel Pitch (H/V)	0.24795 x 0.24795 mm	
	Viewing Angle (H/V)	178°/178°	
Touch	Backlight MTBF (hrs)	30,000 (LED backlight)	
	Touchscreen	Projected capacitive type with 10-point multi-touch	
	Touch Controller	EETI (80H84)	
	Surface Hardness	6H	
System	Coating	Chemical AG etching	
	CPU Support	11th Gen Intel® mobile ULT(UP3) on-board processor Intel® Core™ i5-1145G7E (Tiger Lake ULT platform) Intel® Core™ i7-1185G7E (Tiger Lake ULT platform)	
	LAN Controller	2 x Intel® I225 Ethernet Controller	
	RAM	2 x SO-DIMM DDR4 3200MHz (system max. 128GB)	
	Storage	2 x M.2 2242/60/80 M key (PCIe+SATA) with RAID	
	Audio	2 x 2W speaker	
	I/O Port	Bottom	1 x DC jack 1 x HDMI output 1 x DC output (12V/19V/24V) 1 x USB Type-C (DP + USB 5V/3A) 1 x Audio jack 2 x USB 2.0 2 x 2.5GbE LAN port 4 x USB 3.2 Gen 2 (10Gb/s) port
		Other	1 x Barcode scanner (optional)

System	OSD Function	1 x Power on/off 1 x Reading light on/off 1 x Brightness up 1 x Brightness down 1 x LCD & touch lock on/off 1 x Programmable button	
	Expansion	1 x PCIe Mini (PCIe) 1 x M.2 2230 A-E key (PCIe+USB) 2 x M.2 2260/80 B-M key (PCIe/SATA)	
	LED	1 x Power indicator 1 x RFID indicator 2 x Battery indicator 2 x LED reading light	
Physical	Wi-Fi & Bluetooth	IEEE 802.11ax 2T2R module (Wi-Fi 6E) with BT v5.0 (M.2 2230 A-E key)	
	Construction Material	Front bezel: Aluminum Rear cover: ABS+PC plastic (ENH2900)	
	Mounting	Wall, Stand and Arm; VESA 75/100 compliant	
	Weight (net)	Under 6.8 kg (without battery)	
Environment	Dimensions (LxWxH)	507.5 x 335.5 x 71 mm	
	Operating Temperature	0°C – 40°C	
	Storage Temperature	-20°C – 60°C	
	Humidity	10% – 95% (non-condensing)	
	Vibration	1G	
	Shock	Operating shock:	5G peak acceleration (11ms duration)
		Non-operating shock:	15G peak acceleration (11ms duration)
	IP Level	Front: IP66	
	Thermal	Fanless	
	Power	Power Input	19V DC input
Power Adapter		150W medical power adapter	
Battery		2 slots for Li-ion battery pack	
Certification	EMC & Safety	CE, FCC Class B Part18 EN 60601-1: 2006/A1:2013 (Edition 3.1) EN 60601-1-2: 2015 (Edition 4.0)	

Ordering Information

Part No.	Description
POCm2-W22C-TGL-i5/PC-R10	21.5" 350cd/m ² FHD medical panel PC with 11th generation 10nm Intel® mobile Core™ i5-1145G7E 4.1GHz on-board processor, 802.11a/b/g/n/ac/ax Wi-Fi 6E module, PCAP touchscreen, w/o battery, R10
POCm2-W22C-TGL-i5/PC/4G-R10	21.5" 350cd/m ² FHD medical panel PC with 11th generation 10nm Intel® mobile Core™ i5-1145G7E 4.1GHz on-board processor, one 4GB DDR4 RAM, 802.11a/b/g/n/ac/ax Wi-Fi 6E module, PCAP touchscreen, w/o battery, R10
POCm2-W22C-TGL-i7/PC-R10	21.5" 350cd/m ² FHD medical panel PC with 11th generation 10nm Intel® mobile Core™ i7-1185G7E 4.4GHz on-board processor, 802.11a/b/g/n/ac/ax Wi-Fi 6E module, PCAP touchscreen, w/o battery, R10
POCm2-W22C-TGL-i7/PC/4G-R10	21.5" 350cd/m ² FHD medical panel PC with 11th generation 10nm Intel® mobile Core™ i7-1185G7E 4.4GHz on-board processor, one 4GB DDR4 RAM, 802.11a/b/g/n/ac/ax Wi-Fi 6E module, PCAP touchscreen, w/o battery, R10

Options

Item	Number	Description
RFID	19B00-000430-00-RS	Mifare RFID reader for POCm2-W22C, 13.56MHz, Z641, RFID board + antenna, IEI assembly only
	7J006-RDR6021AKU-RS	RFID reader, 125KHz, RDR-6021AKU, IEI assembly only
DICOM	19B00-000431-00-RS	DICOM board module for POCm2-W22C, Z641, IEI assembly only
TPM	TPM-IN03-R10	20-pin Infineon SPI TPM 2.0 module, software management tool, firmware V7.63

IQ Mounting Options

Item	Part No.
Stand	STAND-A21-R10 (black)
	STAND-A21W-R10 (white)

Packing List

Item	Q'ty	Remark
Power Adapter	1	150W medical power adapter
Power Cord	1	European power cord, 183 cm, C13

I/O Interface

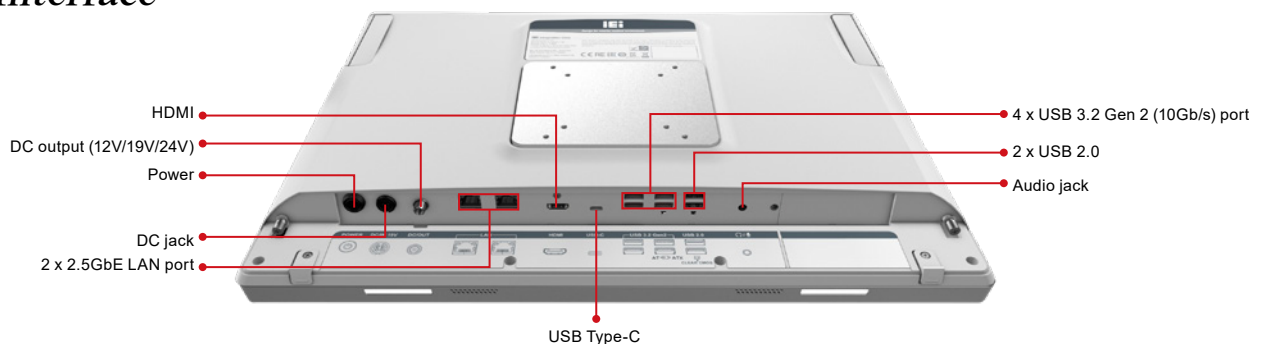

Dimensions (Unit: mm)

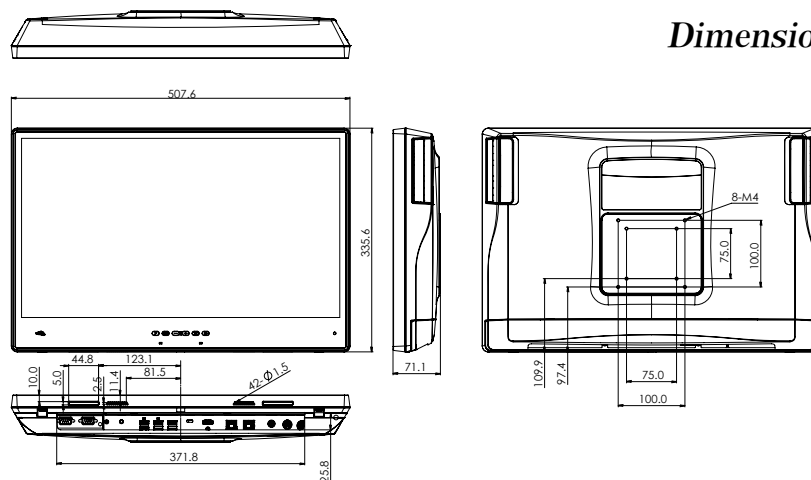

Mobile Point-of-Care Terminal

POCm-W22C-ULT3
POCm-W24C-ULT3

22"/24" Medical Panel PC with 6th Generation Intel® mobile ULT Core™ i7/i5/Celeron® processor



Features

- Intel® Celeron®, Core™ i5/i7 Skylake processor
- Anti-bacteria housing with IP65 front bezel and IP32 rear cover protection
- PCAP touch allows multi-touch, multi-layer gloves and water-on-screen operation
- Three hot-swappable batteries with a total runtime of 8 hours, ideal for non-powered medical carts



» Key Features

3 hot-swappable batteries that can provide sufficient power, and the ergonomic side-facing design eases the use for nurses with different height. Compared to the LiFePO4 battery of the traditional nursing cart, the batteries installed on the POCm have better design by reducing more than 5 kilograms of weight. The battery docking station can perform fast charging, taking only 3.5 hours from 0 to 100%.



• Lightweight Design

Traditionally, the battery of working station is bulky and occupies space. The hot-swappable batteries makes the POCm series an ideal medical cart computer for decreasing the total weight up to 5 kg.

LiFePO4
6.5kg!

3 pcs Lithium-ion
1.38kg

5 kg reduction

• Highly Integration

The POCm series product is a highly integrated panel PC. When building a mobile working station, the easy installation steps prevent you from facing the trouble of integrating different components and messy cabling.



• Cost Effective

The typical price range of nursing cart battery is more than USD 600 (after service included). Our anti-bacteria battery saves more than USD 400 cost. Charging dock design meets the need of medical context and relieves the waste of time and efforts going back and forth between nursing station and ward.



Specifications

Model	POCm-W22C-ULT3	POCm-W24C-ULT3		
LCD Specifications	LCD Size	21.5" (16:9)	23.8" (16:9)	
	Max. Resolution (W/H)	1920 x 1080		
	Brightness (cd/m ²)	250		
	Contrast Ratio	1000:1		
	LCD Color	16.7M (RGB 6-bit + Hi-FRC)		
	Pixel Pitch (H/V)	0.24825 x 0.24825 mm	0.2745 x 0.2745 mm	
	Viewing Angle (H/V)	170°/160°	178°/178°	
Backlight MTBF (hrs)	30,000 (LED backlight)			
Touch	Touchscreen	Projected capacitive type with 10-point multi-touch		
	Touch Controller	EETI		
	Surface Hardness	6H		
System	CPU Support	6th Gen Intel® mobile ULT Core™ i7-6600U / Core™ i5-6300U / Celeron® 3855U		
	LAN Controller	1 x Intel® I211 Ethernet Controller 1 x Intel® I219 Ethernet Controller (AMT 12.x supported by i7/i5 SKUs)		
	RAM	2 x 260-pin 2400/2133MHz dual-channel DDR4 SO-DIMM, 4GB pre-installed (system max. 32GB)		
	Storage	1 x 2.5" accessible SATA HDD bay 2 x M.2 2280 M key (PCIe/SATA) with RAID		
	Audio	2 x 2W speaker		
	Camera & Microphone	5-megapixel CMOS front-facing camera with auto-focus and digital microphone		
	I/O Port	Bottom	Side	
		1 x DC jack 1 x Digital mic 2 x HDMI output 2 x GbE LAN port 2 x RS-232/422/485 4 x USB 3.2 Gen 1 (5Gb/s) port	1 x Mic in 1 x Audio out 2 x USB 2.0 port	
	OSD Function	1 x Power on/off 1 x Volume up 1 x Volume down	1 x Brightness up 1 x Brightness down 1 x LCD on/off and touch lock for cleaning	
	Expansion	1 x Full-size/Half-size PCIe Mini (PCIe+USB)		
	LED	1 x RFID indicator 1 x Power indicator 3 x Battery indicator (color: blue/red)		
Wi-Fi & Bluetooth	IEEE 802.11a/b/g/n/ac 2T2R module with BT v4.2 (M.2 2230 A-E key)			
Physical	Construction Material	ABS+PC plastic with anti-bacterial material		
	Mounting	Wall, Stand and Arm; VESA 75/100 compliant		
	Weight (Net)	7.07 kg (without battery)	8.18 kg (without battery)	
		8.43 kg (with 3 batteries)	9.53 kg (with 3 batteries)	
Dimensions (LxWxH)	543 x 350 x 71mm	594.6 x 379.6 x 71 mm		
Environment	Operating Temperature	0°C – 40°C		
	Storage Temperature	-20°C – 60°C		
	Humidity	10% – 90% (non-condensing)		
	Vibration	1G		
	Shock	Operating shock: 5G peak acceleration (11ms duration) Non-operating shock: 10G peak acceleration (11ms duration)		
	IP Level	Front: IP65		
	Thermal	Fanless		
Power	Power Input	19V DC input		
	Power Adapter	150W medical power adapter		
	Battery	3 slots for Li-ion battery packs		
Certification	CE, FCC Class B Part18 IEC 60601-1: 2005+AMD1:2012 (Edition 3.1) IEC 60601-1-2: 2014 (Edition 4.0)			

Ordering Information

Part No.	Description
22"	POCm-W22C-ULT3-C/PC/4G-R11 21.5" 250cd/m ² FHD medical panel PC with 6th generation 14nm Intel® mobile Celeron® 3855U (15W) 1.6GHz on-board processor (ULT), one 4GB DDR4 RAM, 802.11a/b/g/n/ac Wi-Fi module, PCAP touchscreen, 5-megapixel camera, microphone, w/o battery, R11
	POCm-W22C-ULT3-i5/PC/4G-R11 21.5" 250cd/m ² FHD medical panel PC with 6th generation 14nm Intel® mobile Core™i5-6300U (15W) 2.4GHz on-board processor (ULT), one 4GB DDR4 RAM, 802.11a/b/g/n/ac Wi-Fi module, PCAP touchscreen, 5-megapixel camera, microphone, w/o battery, R11
	POCm-W22C-ULT3-i7/PC/4G-R11 21.5" 250cd/m ² FHD medical panel PC with 6th generation 14nm Intel® mobile Core™i7-6600U (15W) 2.6GHz on-board processor (ULT), one 4GB DDR4 RAM, 802.11a/b/g/n/ac Wi-Fi module, PCAP touchscreen, 5-megapixel camera, microphone, w/o battery, R11
24"	POCm-W24C-ULT3-C/PC/4G-R10 24" 250cd/m ² FHD medical panel PC with 6th generation 14nm Intel® mobile Celeron® 3855U (15W) 2.4GHz on-board processor (ULT), one 4GB DDR4 RAM, 802.11a/b/g/n/ac Wi-Fi module, PCAP touchscreen, 5-megapixel camera, microphone, w/o battery, R10
	POCm-W24C-ULT3-i5/PC/4G-R10 24" 250cd/m ² FHD medical panel PC with 6th generation 14nm Intel® mobile Core™i5-6300U (15W) 2.4GHz on-board processor (ULT), one 4GB DDR4 RAM, 802.11a/b/g/n/ac Wi-Fi module, PCAP touchscreen, 5-megapixel camera, microphone, w/o battery, R10
	POCm-W24C-ULT3-i7/PC/4G-R10 24" 250cd/m ² FHD medical panel PC with 6th generation 14nm Intel® mobile Core™i7-6600U (15W) 2.6GHz on-board processor (ULT), one 4GB DDR4 RAM, 802.11a/b/g/n/ac Wi-Fi module, PCAP touchscreen, 5-megapixel camera, microphone, w/o battery, R10

Options

Item	Number	Description
RFID	19B00-000432-00-RS	Mifare RFID reader for POCm, 13.56MHz, Z641, RFID Board + Antenna, IEI assembly only
TPM	TPM-IN02-R20	Trusted platform module kit, TPM 2.0, IEI assembly only
Charging Docking Station	POCm-DOCKING-6BAY-R10	6-slot battery charger, LED indicator, 15V/280W power adapter
OS Image	POCm-W22C-ULT3-W10E64-V-R10	OS image with Windows Embedded Standard 10 E Value 64-bit 2019 for POCm-W22C/W24C Series
Cable Cover	43106-0272Q7-00-RS	Cable cover for POCm, white, plastic, R10, IEI assembly only
Battery	31603-000069-RS	3S3P Li-ion battery pack, 11.1V, 7800mAh, CCL, RoHS, IEI assembly only

IQ Mounting Options

Item	Part No.
Arm	ARM-31-RS
Stand	STAND-A21-R10 (black)
	STAND-A21W-R10 (white)

Packing List

Item	Q'ty	Remark
Power Adapter	1	150W medical power adapter
Power Cord	1	European power cord, 183 cm, C13

POCm-W22C-ULT3 / POCm-W24C-ULT3 I/O Interface

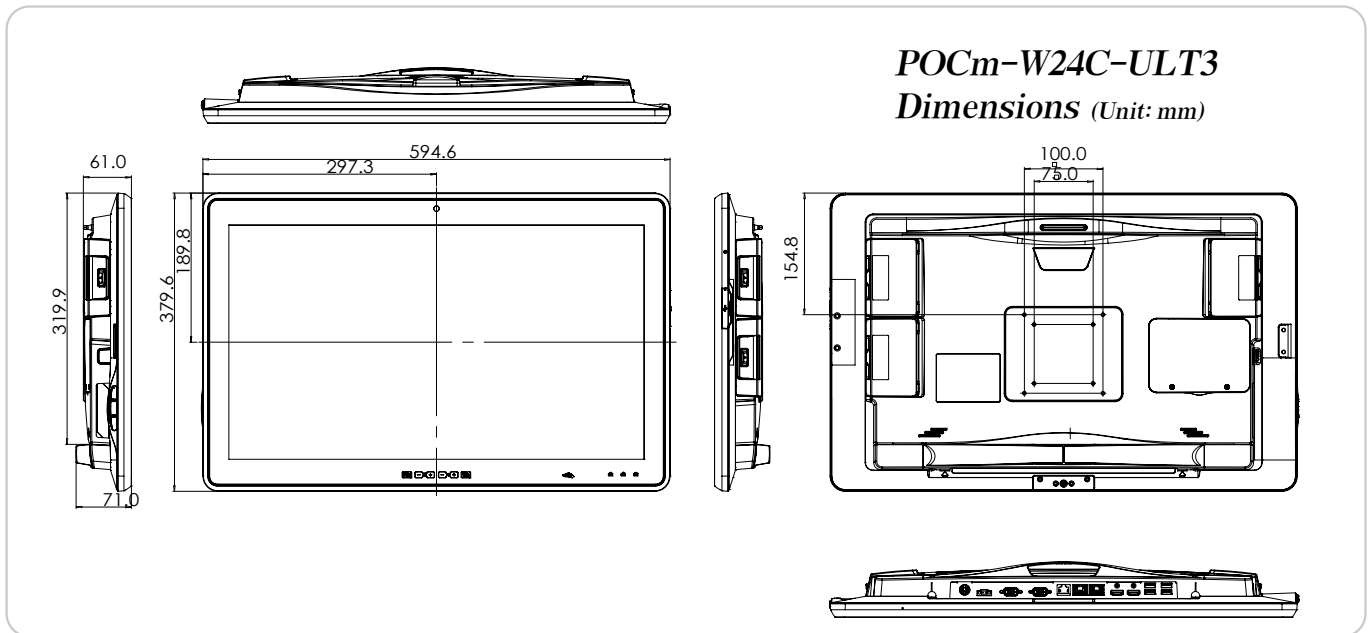
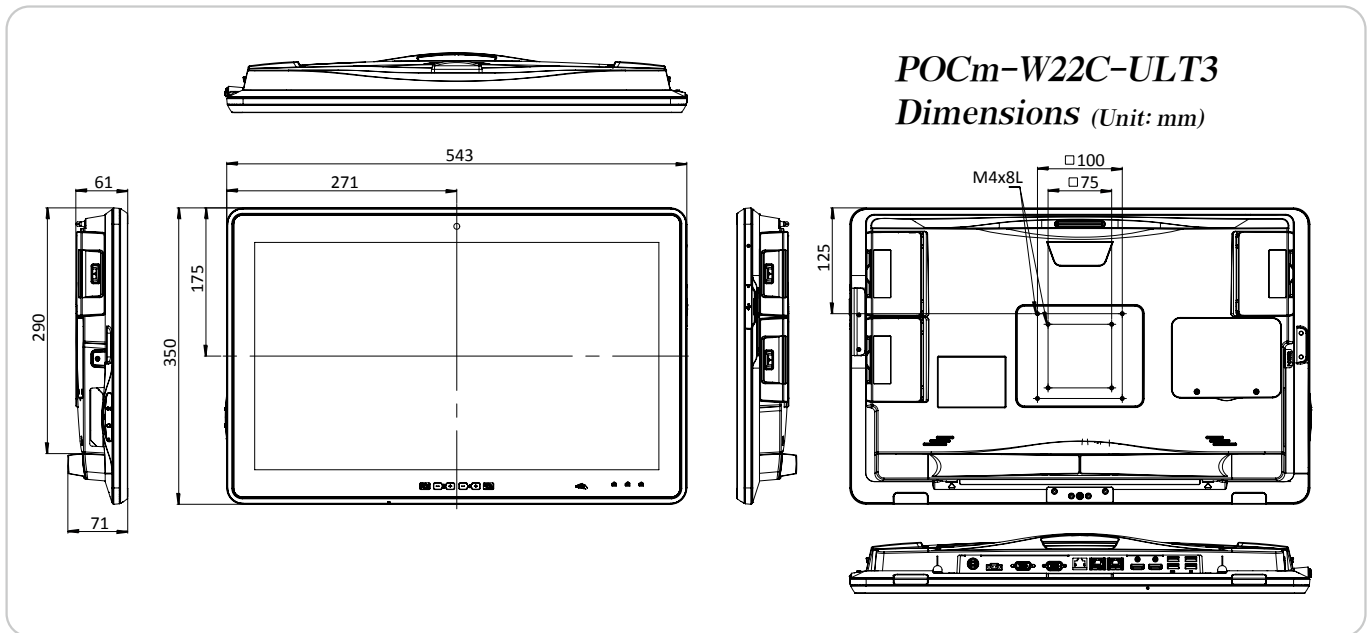
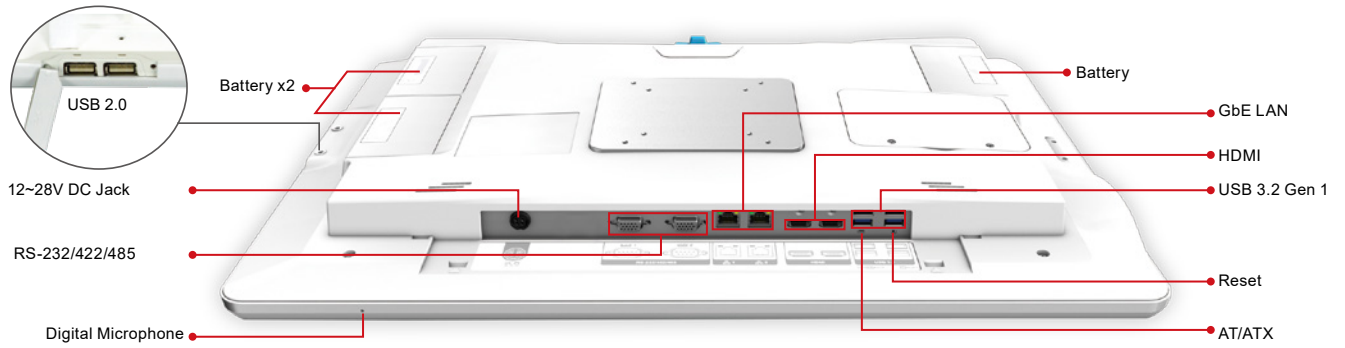

Point-of-Care Terminal

POC-17C-ULT3 | 17" Medical Panel PC with 6th Generation Intel® mobile ULT Core™ i7/i5/Celeron® processor

Features

- 17" 5:4 LED panel (1280 x 1024)
- 6th Generation Intel® mobile ULT Core™ i7-6600U / Core™ i5-6300U / Celeron® 3855U
- Projected capacitive type with 10-point multi-touch
- IP65 compliant front bezel
- Anti-bacteria cover
- RAID function supported (RAID 0 and RAID 1) (only for Core™ i5 or Core™ i7)



● Built-in Camera Cover

The camera cover protects the privacy of patients. The built-in design also makes the maintenance more convenient, and prevents cover loss.



● RAID 0 and RAID 1 Function

The RAID 0/1 capability offers redundancy through mirroring - data is written identically to two drives. Users in the hospital will not need to worry about data lost anymore. (only for Core™ i5 or above)



● E-Window for Multiple Expansion

The reserved PCIe Mini slot for expansion helps system integrators add more functions easily without any additional cost efforts.



E-Window

● Front IP65 Compliance

Easy to clean the front panel by spray and wipe detergent.

● Advanced Touchscreen for Saline

The PCAP touch not only supports multi-touch function but also provides smooth control when operating with gloves. Moreover, we cooperate with our suppliers to work hard on avoiding the accidental operating from sterile saline.



Specifications

Model		POC-17C-ULT3
LCD Specifications	LCD Size	17" (5:4)
	Max. Resolution (W/H)	1280 x 1024
	Brightness (cd/m ²)	350
	Contrast Ratio	1000:1
	LCD Color	16.7M (RGB 6-bit + Hi-FRC)
	Pixel Pitch (H/V)	0.264 x 0.264 mm
	Viewing Angle (H/V)	170°/160°
	Backlight MTBF (hrs)	30,000 (LED backlight)
Touch	Touchscreen	Projected capacitive type with 10-point multi-touch
	Touch Controller	EETI
	Surface Hardness	6H
System	CPU Support	6th Gen Intel® mobile ULT Core™ i7-6600U / Core™ i5-6300U / Celeron® 3855U
	RAM	2 x 260-pin 2400/2133MHz dual-channel DDR4 SO-DIMM, 4GB pre-installed (system max.32GB)
	Storage	1 x mSATA (E-Window) 2 x 2.5" SATA 6Gb/s accessible HDD bay with RAID 0, 1 (RAID is only supported by Core™ i5 and Core™ i7)
	Audio	2 x 2W speaker
	Camera & Microphone	2-megapixel CMOS front-facing camera with auto-focus and digital microphone
	I/O Port	1 x HDMI output 1 x 12V – 28V DC jack 1 x RS-232/422/485 1 x RJ-11 for 1D/2D barcode reader 2 x GbE LAN port 4 x USB 3.2 Gen 1 (5Gb/s) port 4 x USB 2.0 port (2 on the side)
	OSD Function	1 x LCD on/off 1 x Volume up 1 x Volume down 1 x Brightness up 1 x Brightness down 1 x Touch lock button for cleaning Combinations: 1 x Lock/Unlock OSD 1 x Power on/off
	Expansion	1 x E-Window slot (full-size PCIe Mini slot with PCIe/mSATA/USB)
	LED	1 x RFID indicator
	Wi-Fi & Bluetooth	IEEE 802.11a/b/g/n/ac 2T2R module with BT V4.1 (M.2 2230 A-E key)
	Other Features	Auto-dimming Yes
	Physical	Construction Material
Mounting		Wall, Stand and Arm; VESA 75/100 compliant
Weight (Net)		6.0 kg
Dimensions (LxWxH)		435 x 376 x 64.5 mm
Environment	Operating Temperature	0°C – 40°C
	Storage Temperature	-20°C – 65°C
	Humidity	10% – 95% (non-condensing)
	Vibration	1G
	Shock	Operating shock: 5G peak acceleration (11ms duration) Non-operating shock: 15G peak acceleration (11ms duration)
	IP Level	Front: IP65
	Thermal	Fanless
Power	Power Input	19V DC input
	Power Adapter	150W medical power adapter
Certification	EMC & Safety	CE, FCC Class B Part18 IEC 60601-1: 2005+AMD1: 2012 (Edition 3.1) IEC 60601-1-2: 2014 (Edition 4.0)

Ordering Information

Part No.	Description
POC-17C-ULT3-C/PC/4G-R11	17" 350 cd/m ² 1280x1024 panel PC with 6th Generation 14nm Intel® Mobile Celeron® 3855U (15W) 1.6GHz on-board processor (ULT), one 4GB DDR4 RAM, 802.11a/b/g/n/ac Wi-Fi module, PCAP touchscreen, 2-megapixel camera, microphone, R11
POC-17C-ULT3-i5/PC/4G-R11	17" 350 cd/m ² 1280x1024 Panel PC with Intel® 14nm 6th Generation Mobile Core™ i5-6300U (15W) 2.4GHz on-board processor (ULT), 1 x 4GB DDR4 RAM, 802.11a/b/g/n/ac Wi-Fi module, PCAP touchscreen, 2M camera, microphone, R11
POC-17C-ULT3-i7/PC/4G-R11	17" 350 cd/m ² 1280x1024 Panel PC with Intel® 14nm 6th Generation Mobile Core™ i7-6600U (15W) 2.6GHz on-board processor (ULT), 1 x 4GB DDR4 RAM, 802.11a/b/g/n/ac Wi-Fi module, PCAP touchscreen, 2M camera, microphone, R11

Options

Item	Number	Description
RFID	19B00-000433-00-RS	Mifare RFID reader, 13.56MHz, with LED indicator and 100mm antenna, IEI assembly only
TPM	MEDP-TPM-02-R10	Trusted platform module kit with 300mm cable, IEI assembly only
OS Image	POC-17C-ULT3-W10E64-V-R10	OS image with Windows Embedded Standard 10 E Value 64-bit for POC-17C/W24C Series, with DVD-ROM, RoHS
Cable Cover	43103-4506K6-00-RS	Cable cover for POC-17C, white, plastic, R10, IEI assembly only

IQ Mounting Options

Item	Part No.
Wall Mounting Kit	AFLWK-19B
Arm	ARM-31-RS
Stand	STAND-A21-R10 (black)
	STAND-A21W-R10 (white)

Packing List

Item	Q'ty	Remark
Power Adapter	1	150W medical power adapter Input: 90V – 264V AC; Output: 19V DC
Power Cord	1	European power cord, 183 cm, C13



POC-17C-ULT3 I/O Interface

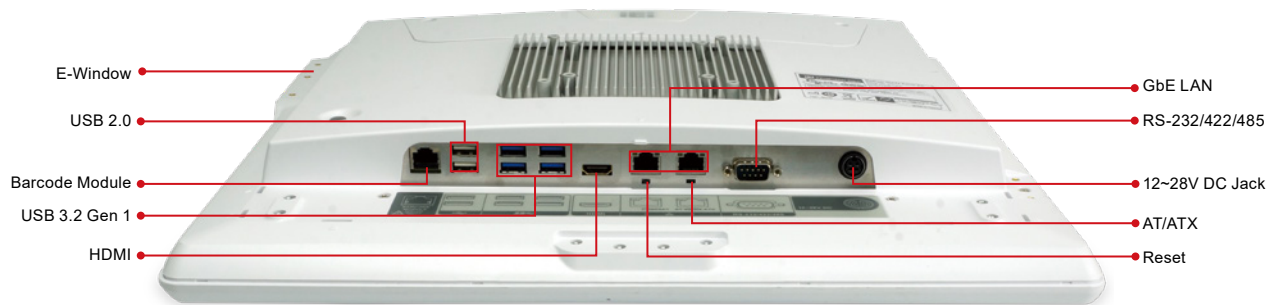

POC-17C-ULT3 Dimensions (Unit: mm)

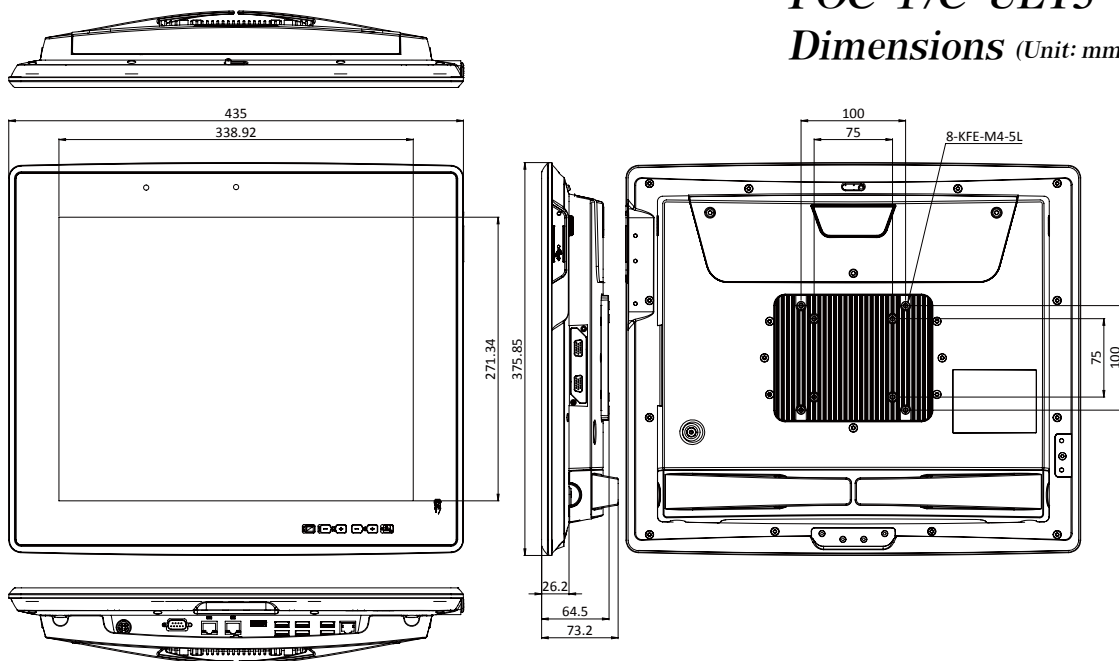

Point-of-Care Terminal

POC-W24C-ULT3 | 24" Medical Panel PC with 6th Generation Intel® mobile ULT Core™ i7/i5/Celeron® processor

Features

- E-Window expansion slot
- Intel® Core™ i5-6300U (Skylake) processor
- Anti-bacteria housing with IP65 front bezel and IP32 rear cover protection
- PCAP touch allows multi-touch, multi-layer gloves and water on screen operation



E-Window

Specifications

Model	POC-W24C-ULT3	
LCD Specifications	LCD Size	24" (16:9)
	Max. Resolution (W/H)	1920 x 1080
	Brightness (cd/m ²)	250
	Contrast Ratio	1000:1
	LCD Color	16.7M (RGB 6-bit + Hi-FRC)
	Pixel Pitch (H/V)	0.2745 x 0.2745 mm
	Viewing Angle (H/V)	178°/178°
	Backlight MTBF (hrs)	30,000 (LED backlight)
Touch	Touchscreen	Projected capacitive type with 10-point multi-touch
	Touch Controller	EETI
	Surface Hardness	6H
System	CPU Support	6th Gen Intel® mobile ULT Core™ i7-6600U / Core™ i5-6300U / Celeron® 3855U 7th Gen Intel® mobile ULT Kaby Lake on-board SoC (By project base)
	RAM	2 x 260-pin 2400/2133MHz dual-channel DDR4 SO-DIMM, 4GB pre-installed (system max. 32GB)
	Storage	1 x mSATA (E-Window) 1 x 2.5" SATA 6Gb/s HDD/SDD bay
	Audio	2 x 3W speaker
	Camera & Microphone	5-megapixel CMOS front-facing camera with auto-focus and digital microphone
	I/O Port	1 x HDMI output 1 x 12V – 28V DC jack 1 x RS-232/422/485 1 x RJ-11 for 1D/2D barcode reader
	OSD Function	1 x LCD on/off 1 x Volume up 1 x Volume down 1 x Brightness up 1 x Brightness down 1 x Touch lock button for cleaning
	Expansion	1 x PCIe Mini reserved for E-Window expansion
	LED	1 x RFID indicator
	Wi-Fi & Bluetooth	IEEE 802.11a/b/g/n/ac 2T2R module with BT v4.1 (M.2 2230 A-E key)
Other Features	Auto-dimming	Yes
	Light Sensor	Ambient light sensor for panel brightness adjustment
	Construction Material	ABS+PC plastic with anti-bacterial material
Physical	Mounting	Wall, Stand and Arm; VESA 75/100 compliant
	Weight (Net)	7.5 kg
	Dimensions (LxWxH)	594.6 x 379.6 x 60.68 mm
Environment	Operating Temperature	0°C – 40°C
	Storage Temperature	-20°C – 60°C
	Humidity	10% – 95% (non-condensing)
	Vibration	1G
	Shock	Operating shock: 5G peak acceleration (11ms duration) Non-operating shock: 15G peak acceleration (11ms duration)
	IP Level	Front: IP65
Power	Thermal	Fanless
	Power Input	19V DC input
Certification	Power Adapter	150W medical power adapter CE, FCC Class B Part18
	EMC & Safety	IEC 60601-1: 2005+AMD1: 2012 (Edition 3.1) IEC 60601-1-2: 2014 (Edition 4.0)

Ordering Information

Part No.	Description
POC-W24C-ULT3-C/PC/4G-R11	24" 250cd/m ² FHD medical panel PC, Intel® Skylake dual-core Celeron® 3855U processor (1.60 GHz), one 4GB DDR4, 802.11a/b/g/n/ac, PCAP touchscreen, 5-megapixel camera, microphone, R11
POC-W24C-ULT3-i5/PC/4G-R11	24" 250cd/m ² FHD medical panel PC, Intel® Skylake dual-core Core™ i5-6300U processor (2.4 GHz), one 4GB DDR4, 802.11a/b/g/n/ac, PCAP touchscreen, 5-megapixel camera, microphone, R11
POC-W24C-ULT3-i7/PC/4G-R11	24" 250cd/m ² FHD medical panel PC, Intel® Skylake dual-core Core™ i7-6600U processor (2.60 GHz), one 4GB DDR4, 802.11a/b/g/n/ac, PCAP touchscreen, 5-megapixel camera, microphone, R11

Options

Item	Number	Description
RFID	19B00-000434-00-RS	Mifare RFID reader, 13.56MHz, with LED indicator, 200mm antenna, RFID & LED cable, IEI assembly only
TPM	MEDP-TPM-03-R10	Trusted platform module kit with 150mm cable, IEI assembly only
OS Image	POC-17C-ULT3-W10E64-V-R10	OS image with Windows Embedded Standard 10 E Value 64-bit for POC-17C/W24C Series, with DVD-ROM, RoHS
Cable Cover	41006-1079K6-00-RS	Cable cover for POC-W24C, white, plastic, R10, IEI assembly only

IQ Mounting Options

Item	Part No.
Wall Mounting Kit	AFLWK-19B
Arm	ARM-31-RS
Stand	STAND-A21-R10 (black)
	STAND-A21W-R10 (white)

Packing List

Item	Q'ty	Remark
Power Adapter	1	150W medical power adapter Input: 90V – 264V AC; Output: 19V DC
Power Cord	1	European power cord, 183 cm, C13



POC-W24C-ULT3 I/O Interface

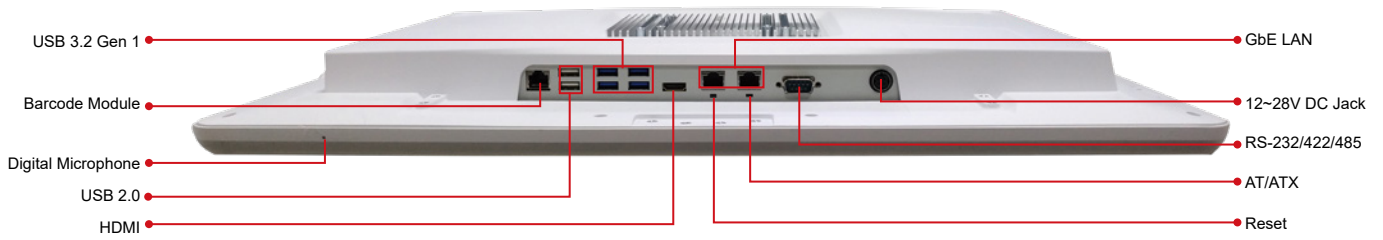

POC-W24C-ULT3 Dimensions (Unit: mm)

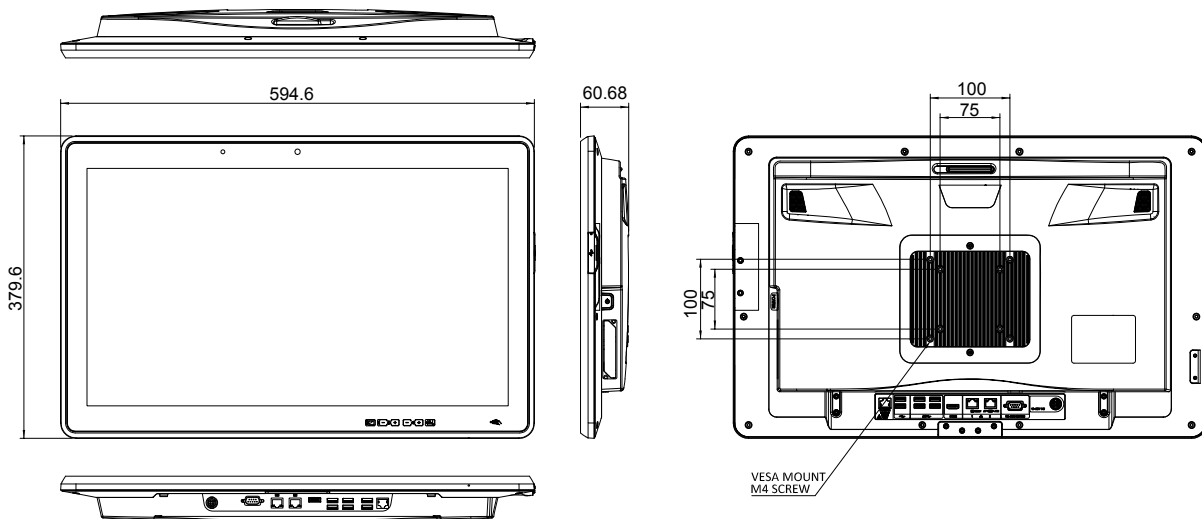



Mobile Medical Monitor

MPOCm-W24 | 24" Medical monitor with 3 hot-swappable batteries

Features

- IP65 front bezel
- 2 variable DC outputs
- 10-point PCAP touchscreen
- Hot-swappable batteries
- Intelligent working station
- 23.8" FHD medical monitor
- Internal Wi-Fi antenna



Fanless

2DC
Outputs

IP65

10
PCAP
touchscreen

Battery

Full HD
1080

» Three hot-swappable batteries

The MPOCm-W24 is a medical monitor with 3 hot-swappable batteries, and it can perfect fit with thin client box PC. It is ideal for improving caregivers' working efficiency and mobility.



» Easy Sterilization

The IP65 front bezel and true flat OSD button design with no inaccessible corners bring conveniences to cleaning work and increase cleaning efficiency.

Battery Indicators

True flat OSD button design



Specifications

Model		MPOCm-W24/PC-R10
LCD Specifications	LCD Size	23.8"
	Max. Resolution (W/H)	1920 x 1080
	Brightness (cd/m ²)	250
	Contrast Ratio	1000:1
	LCD Color	16.7M (RGB 6-bit + Hi-FRC)
	Pixel Pitch (H/V)	0.2745 x 0.2745 mm
	Viewing Angle (H/V)	178°/178°
	Backlight MTBF (hrs)	30,000 (LED backlight)
Touch	Touchscreen	Projected capacitive type with 10-point multi-touch
	Touch Controller	EETI
	Surface Hardness	6H
System	Audio	2 x 3W speaker
	I/O Port	1 x HDMI-in 1 x DC-in jack 1 x USB 2.0 (black, Type-B) for Touch 1 x USB 3.2 Gen 1 (blue, Type-B) 2 x USB 3.2 Gen 1 (blue, Type-A) 2 x Wi-Fi SMA connector (main/aux) 2 x Variable voltage DC power output for external devices (55W in total) DC OUT1: 19V, 24V (45 watts sustained, maximum of 55 watts) DC OUT2: 5V, 12V, 15V, 19V, 24V (10 watts sustained, maximum of 50 watts) *To use battery power, at least 2 batteries must be installed and the DC outputs must work properly.
	OSD Function	1 x LCD on/off 1 x Volume up 1 x Volume down 1 x Brightness up 1 x Brightness down 1 x OSD menu Key
	LED	1 x Power indicator 3 x Battery indicator (color: blue/orange)
	Battery Management APP	EC UART to USB, output to the box PC
Physical	Construction Material	ABS+PC plastic with anti-bacterial material
	Mounting	Wall, Stand and Arm; VESA 75/100 compliant
	Weight (Net)	8.18 kg (without battery) 9.53 kg (with 3 batteries)
	Dimensions (LxWxH)	594.6 x 379.6 x 63.2 mm
Environment	Operating Temperature	0°C – 40°C
	Storage Temperature	-20°C – 60°C
	Humidity	10% – 90% (non-condensing)
	Vibration	1G
	Shock	Operating shock: 5G peak acceleration (11ms duration) Non-operating shock: 10G peak acceleration (11ms duration)
	IP Level	Front: IP65
	Thermal	Fanless
Power	Power Input	19V DC input (4-pin)
	Power Adapter	150W medical power adapter
	Battery	Up to 3 hot-swappable TC-202 batteries
Certification	EMC & Safety	CE, FCC Class B Part 18 EN 60601-1: 2006/A1:2013 (Edition 3.1) EN 60601-1-2: 2015 (Edition 4.0)

Ordering Information

Part No.	Description
MPOCm-W24/PC-R10	23.8" 250cd/m ² FHD medical monitor, 2 DC outputs, PCAP touchscreen, support 3 TC-202 batteries, R10
MPOCm-W24-R10	23.8" 250cd/m ² FHD medical monitor, 2 DC outputs, support 3 TC-202 batteries, R10

Options

Item	Number	Description
Charging Docking Station	POCm-DOCKING-6BAY-R10	6-slot battery charger, LED indicator, 15V/280W power adapter
Cable Cover	43106-0272Q7-00-RS	Cable cover for MPOCm, white, plastic, R10, IEI assembly only
Battery	31603-000069-RS	3S3P Li-ion battery pack, 11.1V, 7800mAh, CCL, RoHS, IEI assembly only
	MEDP-HSBAT-R10	3S3P Li-ion battery pack, 11.1V, 7800mAh (for eco packing, an order of at least 14 pcs per box or multiple of 14 pcs)

IQ Mounting Options

Item	Part No.
Wall Mount Kit	AFLWK-19B
Arm	ARM-31-RS
Stand	STAND-A21-R10

Packing List

Item	Q'ty	Remark
Power Adapter	1	150W medical power adapter; input: 90V – 264V AC; output: 19V DC
Power Cord	1	European power cord, 183 cm, C13

I/O Interface

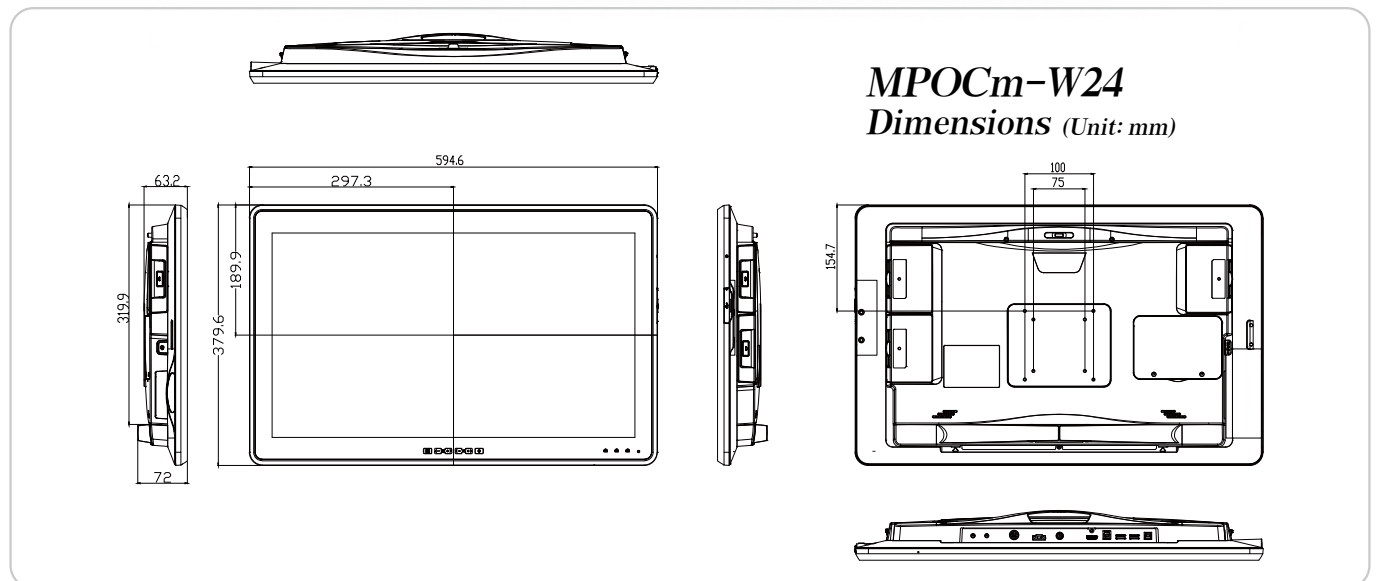
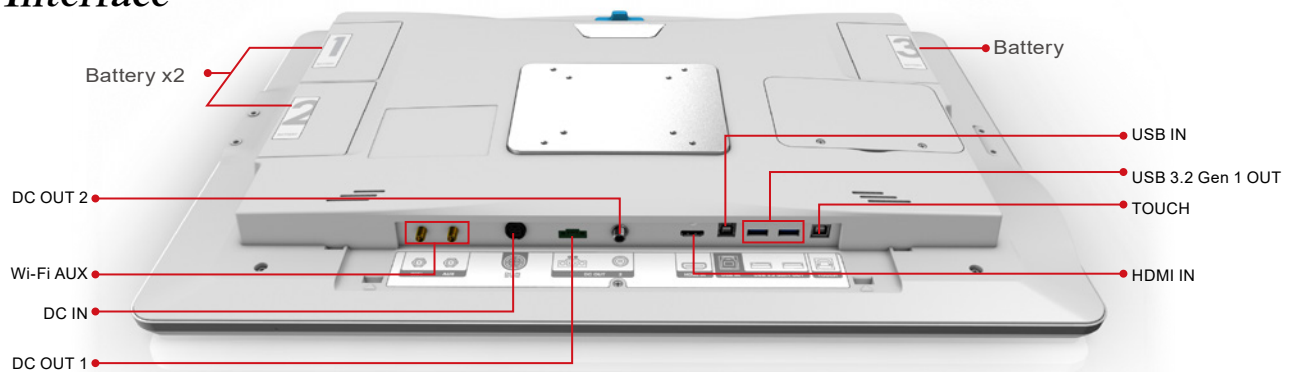

Medical Grade Box PC & Edge AI Computing

With the advance of medical technology, more and more computing systems are adopted by various healthcare professionals for EMR integration, AI computing, medical information transfer, HMI and various medical applications.

The entire HTB series is developed to help our global partners to tackle the foreseeable growing opportunities in hospital digitalization, precision medicine, and artificial intelligence in healthcare.

» HTB-100



- Desktop CPU
- Isolated RS-232
- Optional PCIe x16 expansion slot
- Support up to three independent displays

The HTB-100 is a medical grade fanless system with Intel® desktop CPU. It can serve as a medical controller or a medical gateway.



» HTB-210



- Smart fan design
- PCIe x16 slot for GPU cards
- Server grade & desktop CPU
- Small size for easy deployment
- PCIe x4 slot for expansion cards

It adopts Intel® Xeon® or Core™ processor and features smart fan control to minimize the noise generated by system thermal solution. It is a perfect AI landing platform for algorithm development or applications in startup companies.



Selection Guide



Series		HTB	
Model		HTB-100-HM170	HTB-210-Q470
Chassis	Color	Silver + grayish blue	White
	Dimension (LxWxH)	294 x 209 x 90.2 mm	140 x 306.7 x 171 mm
	Thermal	Fanless	Smart fan
	Chassis Construction	Extruded aluminum alloy	Metal housing (SECC)
Motherboard	CPU	Intel® Core™ i5-6442EQ (6M cache, up to 2.70GHz, 25W) Intel® Core™ i7-6822EQ (8M cache, up to 2.80GHz, 25W)	Intel® Core™ i5-10500TE (6-core, 35W TDP)
	Chipset	Intel® HM170	Intel® Q470
	System Memory	2 x 260-pin DDR4 SO-DIMM (4GB pre-installed, system max. 32GB)	2 x 260-pin 2666/2133MHz dual-channel DDR4 SO-DIMM ECC & non-ECC unbuffered (system max. 128GB)
Storage	Hard Drive	1 x 2.5" SATA HDD/SSD bay	1 x 2.5" SATA HDD/SSD bay
I/O Interfaces	USB	2 x USB 2.0 4 x USB 3.2 Gen 1 (5Gb/s)	1 x USB Type-C (USB/DP) 2 x USB 3.2 Gen 1 (5Gb/s) 2 x USB 2.0 (front side)
	Ethernet	2 x RJ-45 PCIe GbE by Intel® I211 controller	2 x Intel® I225-V PCIe controller (2.5GbE)
	COM Port	2 x RS-232 (DB-9, with 2.5 kV isolation) 2 x RS-232/422/485 (DB-9, with 2.5 kV isolation)*	1 x RS-232/422/485
	Display	1 x VGA 1 x HDMI 2.0 1 x iDP (optional)	1 x HDMI
	Resolution	VGA: up to 1920 x 1200 @60HZ HDMI 2.0: up to 4096 x 2160 @60Hz	HDMI: up to 4096 x 2304 @30Hz
	Audio	1 x Mic-in 1 x Line-in 1 x Line-out Realtek ALC662, 5.1-channel High Definition Audio (HDA)	-
	Wireless	1 x 802.11a/b/g/n/ac 2T2R (optional)	-
	Others	-	1 x Power button 1 x AT/ATX switch
Expansions	PCIe	1 x PCIe x16	1 x PCIe 3.0 x4 1 x PCIe 3.0 x16
	PCIe Mini	1 x Half-size PCIe Mini 1 x Full-size PCIe Mini (supports mSATA, colay with SATA)	-
	M.2	1 x M.2 1630/2230/3030 A-E key (PCIe x2/USB 2.0)	1 x M.2 2230 A key (PCIe x2 and USB 2.0) 1 x M.2 2280 M key (PCIe x4 and SATA)
	Acceleration Card (optional)	-	Quadro P2200 (75W) NVIDIA Tesla T4 (75W)
Power	Power Input	12V – 28V DC	19V DC
	Power Consumption	19V @4.4A (Intel® Core™ i7-6822EQ with 4GB memory)	19V @4.8A
	Adapter	90V – 264V AC input, 19V DC output; 150W	100V – 240V AC input, 19V DC output, 180W
Reliability	Mounting	Wall mount	-
	Operating Temperature	0°C – 40°C, with air flow (SSD)	0°C – 40°C
	Operating Humidity	10% – 95% (non-condensing)	10% – 95% (non-condensing)
	Storage Temperature	-40°C – 70°C, with air flow (SSD)	-20°C – 60°C
	Storage Humidity	10% – 90% (non-condensing)	-
	Operating Shock	Half-sine wave shock 5G; 11ms; 100 shocks per axis	Half-sine wave shock 5G, 11ms, 100 shocks per axis
	Operation Vibration	MIL-STD-810G 514.6 C-1 (with SSD)	MIL-STD-810G 514.6C-1 (with SSD)
Weight (Net/Gross)	2.2 kg/3.0 kg	2.8 kg	
Certification	Safety/EMC	CE, FCC class B part 18 IEC 62304 IEC 60601-1 V3.1 IEC 60601-1-2 V4.0 ISO 14971:2007	UL/cUL FCC Part15B EN 62368-1 Ed.2 + RMF EN 55032 + EN 55035
OS	Supported OS	Microsoft Windows 10, Microsoft Embedded Standard 7	Windows 11, Windows 10, Linux

NEW

AI Box PC

HTB-210-Q470 | 10th Gen Intel® Core™ processor

Features

- 10th Gen Intel® Core™ processor platform with Intel® Q470 chipset
- PCIe x4 slot supports capture cards or other applications
- Compact edge device with great computing & graphics performance
- PCIe x16 slot supports NVIDIA GPU acceleration card
- Two 260-pin 2666/2133MHz Dual-Channel DDR4 SODIMM unbuffered Memory supported up to 128GB



» Dual PCIe Slots

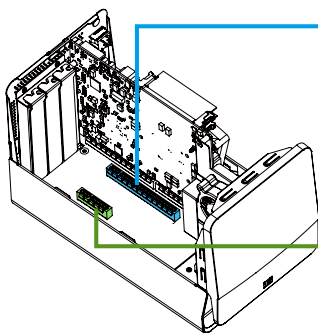

PCle x16

Accelerator cards are crucial to data scientists. High compatibility for the GPU cards such as NVIDIA P4/T4/Quadro series allows the end user to choose accelerator cards based on their different needs.

PCle x4

The redundant PCIe x4 slot is reserved for all-in-one video capture cards or other expansions.

» Unique Thermal Solution

The accessible hard drive enables IT technicians to do the maintenance work more easily. The drive bay is located in the bottom of the HTB-210 and accepts 2.5" SSD or HDD. The IT technician can easily check or replace the storage device by removing four cover screws.

Catering to NVIDIA® Tesla T4 passive heat sink design, IEI adopts blower-ventilation solution that not only creates a strong air flow but also minimizes the noise made by fan system.

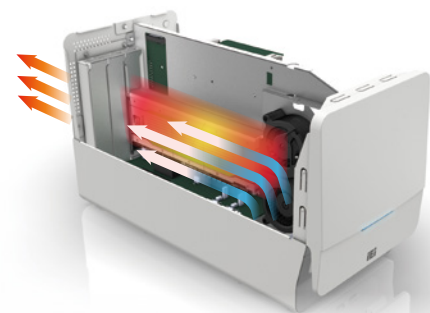

» Easy Maintenance

The accessible hard drive enables IT technicians to do the maintenance work more easily. The drive bay is located in the bottom of the HTB-210 and accepts 2.5" SSD or HDD. The IT technician can easily check or replace the storage device by removing four cover screws.



Specifications

Model		HTB-210-Q470
Chassis	Color	White
	Dimension (LxWxH)	140 x 306.7 x 171 mm
	Thermal	Smart Fan
	Chassis Construction	Metal Housing (SECC)
Motherboard	CPU	Intel® Core™ i5-10500TE (6-core, 35W TDP)
	Chipset	Intel® Q470
	System Memory	2 x 260-pin 2666/2133MHz dual-channel DDR4 SO-DIMM ECC & non-ECC unbuffered (system max. 128GB)
Storage	Hard Drive	1 x 2.5" SATA HDD/SSD bay
I/O Interfaces	USB	1 x USB Type-C (USB/DP) 2 x USB 3.2 Gen 1 (5Gb/s) 2 x USB 2.0 (front side)
	Ethernet	2 x Intel® I225-V PCIe controller (2.5GbE)
	COM port	1 x RS-232/422/485
	Display	1 x HDMI
	Resolution	HDMI: up to 4096 x 2304 @30Hz
	Others	1 x Power button 1 x AT/ATX switch
	Expansions	PCIe
M.2		1 x M.2 2230 A key (PCIe x2 and USB 2.0) 1 x M.2 2280 M key (PCIe x4 and SATA)
Acceleration Card (Optional)		NVIDIA Tesla T4 (75W) Quadro P2200 (75W)
Power	Power Input	19V DC
	Power Consumption	19V @4.8A
	Power Adapter	100V – 240V AC input, 19V DC output, 180W
Reliability	Operating Temperature	0°C – 40°C
	Operating Humidity	10% – 95% (non-condensing)
	Storage Temperature	-20°C – 60°C
	Operating Shock	Half-sine wave shock 5G, 11ms, 100 shocks per axis
	Operation Vibration	MIL-STD-810G 514.6C-1 (with SSD)
	Weight (Net)	2.8 kg
Certification	Safety / EMC	UL/ cUL FCC Part15B EN 62368-1 Ed.2 + RMF EN 55032 + EN 55035
OS	Supported OS	Windows 11, Windows 10, Linux

Ordering Information

Part No.	Description
HTB-210-Q470/2A-R10	Embedded system w/o CPU, w/o RAM, one PCIe x16 slot, one PCIe x4 slot, 19V DC 230W power adapter, white, for ATO only, R10
19FHTB210-000001-RS	Fan module for NVIDIA Tesla T4, CCL, RoHS

Packing List

Item	Part No.	Q'ty	Remark
Power Adapter	63040-010180-200-RS	1	180W power adapter Input: 100V – 240V AC; Output: 19V DC
Power Cord	32702-000200-100-RS	1	European power cord, 180 cm, C13
HDD Screws	44043-030041-RS	4	Machine screw; I head; M3x4

I/O Interface

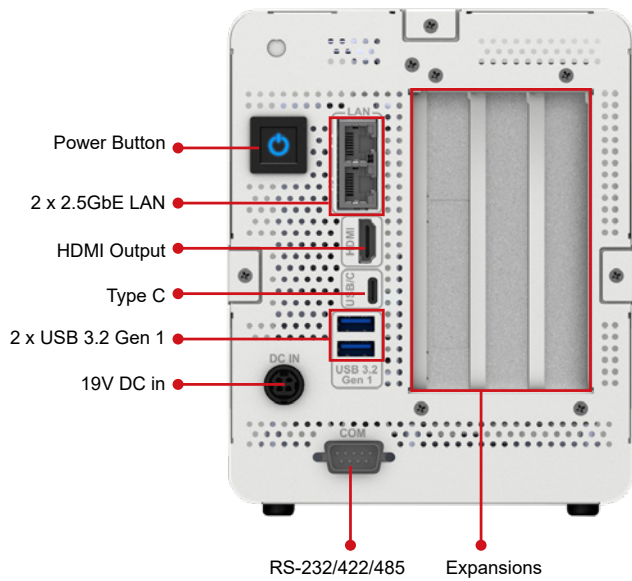

HTB-210-Q470 Dimensions

(Unit: mm)

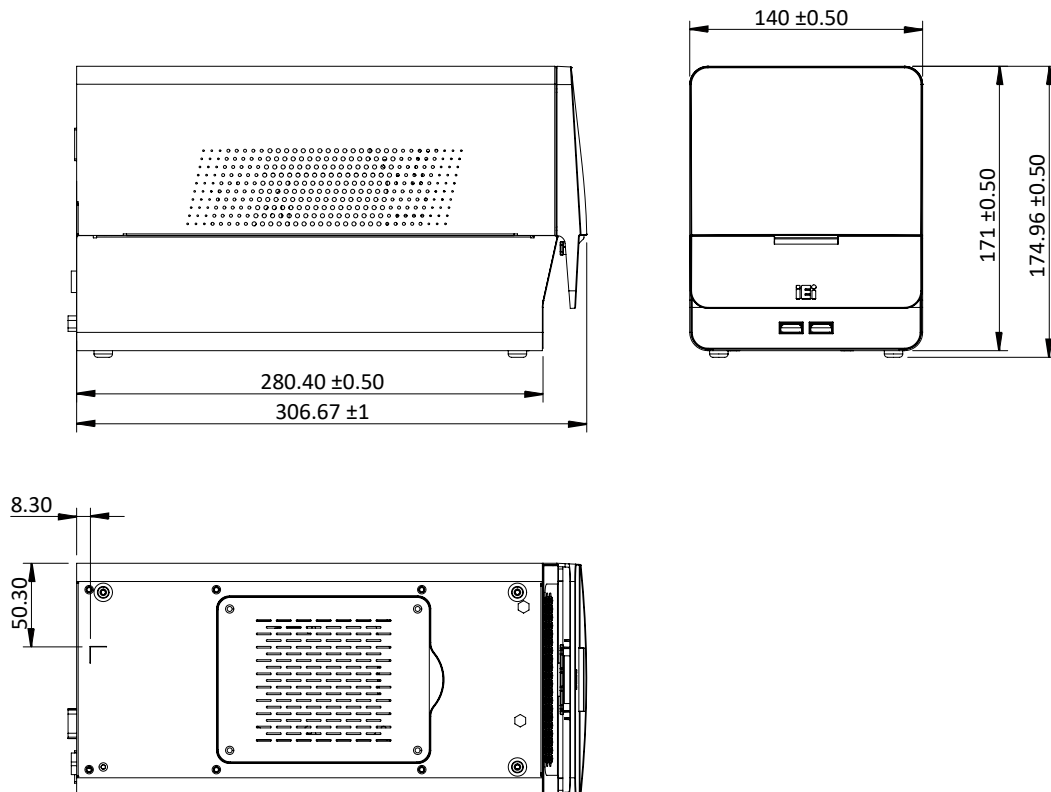

Medical Box PC

HTB-100-HM170 | Fanless Quad Core Box PC

Features

- Triple independent display with high resolution support
- Isolated COM ports for enhancing safety among devices
- Optional PCIe x16 expansion slot supports more flexible functions
- Medical grade with high performance fanless embedded computing
- 6th Gen Intel® Core™ processor platform with Intel® HM170 chipset and DDR4 memory



» Smart & Friendly Design

Isolated COM ports, rich I/O interface, and multiple expansions are built in to the HTB-100. The intelligent HTB-100 medical computing system will meet all demands from the medical applications.



• Compliant with medical standards

The HTB-100 is compliant with medical standards, including IEC 60601-1 V3.1, IEC 60601-1-2 V4.0, IEC 62304, IEC 62366, ISO 14971 and FCC part 18 class B, making the medical environment more reliable.

• Flexible expansion

The flexible expansion is one of the advantages of the HTB-100 for medical applications. The HTB-100 reserves a PCIe x16 slot for add-on card expansions, such as capture card for medical imaging inspection during surgery.

• Waterproof top cover

The HTB-100 is equipped with a waterproof top cover in order to prevent any damage from cleaning or liquid which may indirectly affect patients. The HTB-100 can meet flat design and reduce maintenance effort.

• Cable cover for easy cabling

The cable cover protects the HTB-100 from dust and liquid ingress, and allows the medical staff to easily manage all the cables from the I/O ports, making the cleaning process more convenient in medical environment.



Powerful system design capability with innovative technology



● Isolated COM ports for safety protection

The COM ports support 2.5kV isolation that meets medical standard (IEC 60601-1-2 V4.0). The isolated ports can increase safety on device designed for medical environment, and provide comprehensive protection against electrical surges for patients and medical staffs.

● Fanless and easy maintenance

The HTB-100 is a fanless embedded system, and the heatsink is situated on the bottom side. The design makes the HTB-100 an easy-to-clean and reliable system for the medical environment.

● Ground pin to prevent harm to patients and medical staffs

The perfect grounding pin design can avoid electric current flowing from the HTB-100 to vital devices which connect to patients, and to avoid the current damage from other devices.

● Easy mounting design

Various mounting methods such as desktop and wall mount are supported for easy use in medical environment. The provided flexible mounting bracket can be oriented 180 degrees to change from desktop to wall mount.



Specifications

Model	HTB-100-HM170		
Chassis	Color	Silver + Grayish blue	
	Dimension (L x W x H)	294 x 209 x 90.2 mm	
	Thermal	Fanless	
	Chassis Construction	Extruded aluminum alloy	
Motherboard	CPU	Intel® Core™ i5-6442EQ (6M cache, up to 2.70GHz, 25W) Intel® Core™ i7-6822EQ (8M cache, up to 2.80GHz, 25W)	
	Chipset	Intel® HM170	
	System Memory	2 x 260-pin DDR4 SO-DIMM (4GB pre-installed, system max. 32GB)	
Storage	Hard Drive	1 x 2.5" SATA HDD/SSD bay	
	USB	2 x USB 2.0 4 x USB 3.2 Gen 1 (5Gb/s)	
I/O Interfaces	Ethernet	2 x RJ-45 PCIe GbE by Intel® I211 controller 2 x RS-232 (DB-9, with 2.5 kV isolation)	
	COM port	2 x RS-232/422/485 (DB-9, with 2.5 kV isolation)	
	Display	1 x VGA, 1 x HDMI 2.0, 1 x iDP (optional)	
	Resolution	VGA: up to 1920 x 1200 @60HZ HDMI 2.0: up to 4096 x 2160 @60HZ	
	Audio	1 x Mic-in 1 x Line-in 1 x Line-out	Realtek ALC662, 5.1-channel High Definition Audio (HDA)
		Wireless	1 x 802.11a/b/g/n/ac 2T2R (optional)
		PCIe	1 x PCIe x16
	Expansions	PCIe Mini	1 x Half-size PCIe Mini 1 x Full-size PCIe Mini (supports mSATA, colay with SATA)
		M.2	1 x M.2 1630/2230/3030 A-E key (PCIe x2/USB 2.0)
		Power Input	12V – 28V DC
Power	Power Consumption	19W @4.4A (Intel® Core™ i7-6822EQ with 4GB memory)	
	Adapter	90V – 264V AC input, 19V DC output; 150W	
Reliability	Mounting	Wall mounting	
	Operating Temperature	0°C – 40°C, with air flow (SSD)	
	Operating Humidity	10% – 95% (non-condensing)	
	Storage Temperature	-40°C – 70°C, with air flow (SSD)	
	Storage Humidity	10% – 90% (non-condensing)	
	Operating Shock	Half-sine wave shock 5G; 11ms; 100 shocks per axis	
	Operation Vibration	MIL-STD-810G 514.6 C-1 (with SSD)	
	Weight (Net / Gross)	2.2 kg/3.0 kg	
Certification	Safety / EMC	CE	
		IEC 62304	
		IEC 60601-1 V3.1	
		IEC 60601-1-2 V4.0	
		ISO 14971:2007	
OS	Supported OS	FCC class B part 18	
		Microsoft Windows 10, Microsoft Embedded Standard 7	

Ordering Information

Part No.	Description
HTB-100-HM170-i5/4G-R10	Ruggedized fanless embedded system with Intel® Core™ i5-6442EQ 1.9 GHz (up to 2.7 GHz, quad core, TDP 25W), 4GB DDR4 pre-installed memory, one PCIe x16 expansion, VGA/HDMI/iDP, COM port, 12V~28V DC, power adapter
HTB-100-HM170-i7/4G-R10	Ruggedized fanless embedded system with Intel® Core™ i7-6822EQ 2.0 GHz (up to 2.8 GHz, quad core, TDP 25W), 4GB DDR4 pre-installed memory, one PCIe x16 expansion, VGA/HDMI/iDP, COM port, 12V~28V DC, power adapter

Packing List

Item	Part No.	Q'ty	Remark
Power Adapter	63040-010150-400-RS	1	Vin: 90 – 264V AC; 150W; Dim: 85 x 170 x 42.5mm; Plug: 6.5mm; Cable: 1,200 mm; Medical; Vout:19VDC; Din 4-Pin/lock; CCL; R10

I/O Interface

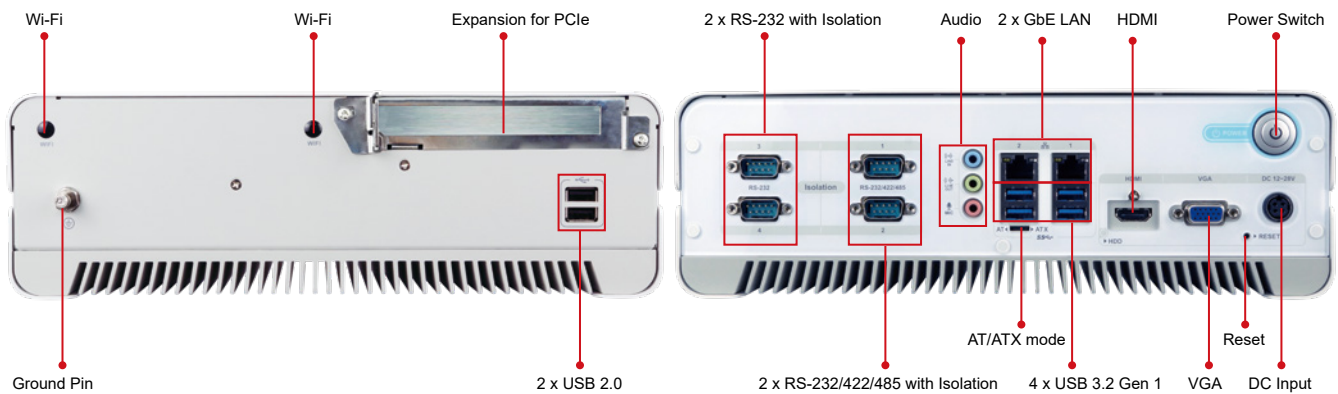

HTB-100-HM170 Dimensions (Unit: mm)

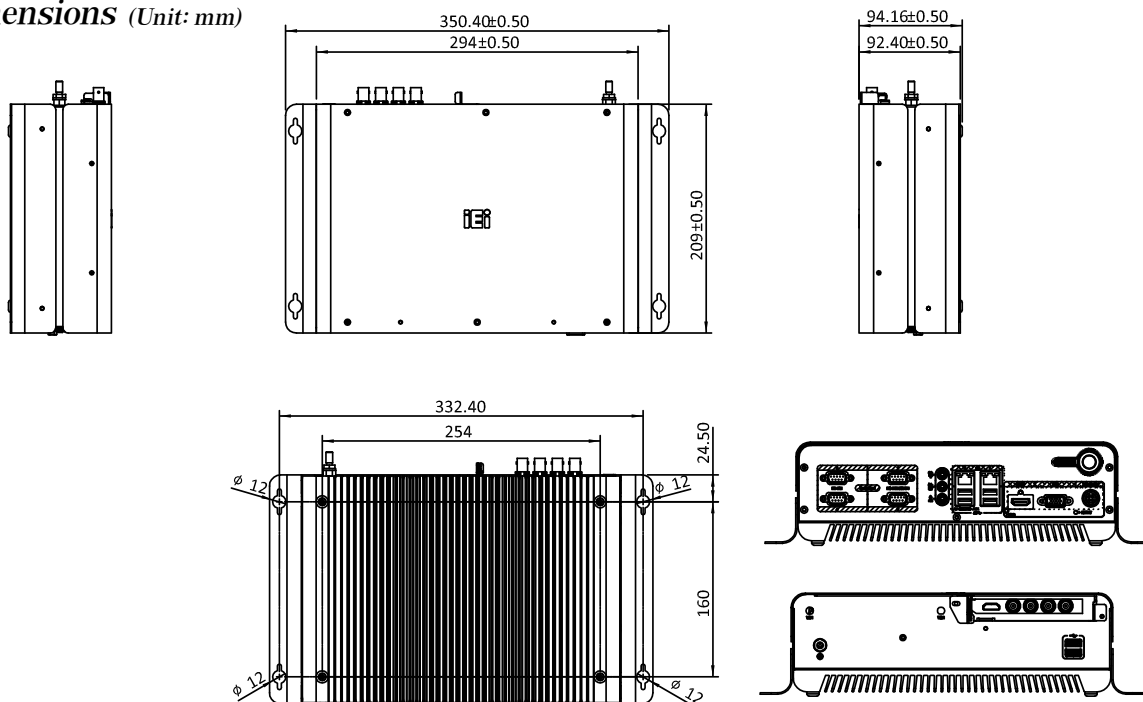

Medical Power



With the advance of medical technology, more and more computing systems are adopted by various healthcare professionals for EMR integration, AI computing, medical information transfer, HMI and various medical applications.

The series is developed to help our global partners to tackle the foreseeable growing opportunities in hospital digitalization, precision medicine, and artificial intelligence in healthcare.

» AXON-mPOWER

With two 12V/15V/19V/24V configurable power outputs to support diverse POC and medical peripherals



» POCm-DOCKING-6BAY

Battery docking station with fast charging which takes only 3.5 hours to charge from 0 to 100%



Medical Grade Power System

NEW

AXON-mPOWER

With two 12V/15V/19V/24V configurable power outputs to support diverse POC and medical peripherals

Features

- 2 x 7800mAh high-capacity Lithium-ion battery pack
- 6 – 12 hours runtime (depending on system power consumption)
- Fast charge design - less than 3.5 hrs from 0% to 100%
- Real-time battery monitoring by mPOWER APP
- Compliant with IEC 60601-1-2 4th edition and IEC 60601-1
- VESA 75/ 100 mount for easy installation onto POC systems
- 2 x 12V/15V/19V/24V configurable power output to support diverse POC and medical peripherals
- 1 x USB Type-C port



Specifications

Model		AXON-mPOWER
Battery	Battery Pack Type	2 x 3S3P Lithium-ion batteries
	Battery Pack Capacity	2 x 7800 mAh (2 x 87Wh) 2 batteries support 6 – 12 hours runtime (depending on system power consumption)
	Normal Voltage	11.1 V
	Battery Life Time	300 cycles > 70%
	Charge Time	210 mins. from 5% – 95% (2A charge for each battery pack)
	Charge Voltage	12.6 V
	Continuous Charge Current	2 A for each battery
	Continuous Discharge Current	5 A (each battery pack's discharge power < 55.5W at 40 °C)
	Maximum Discharge Current	7 A (each battery pack's discharge power < 77.7W at 25 °C)
	Discharge Cut-off Voltage	8.25 V
Power	DC-out Power	110W maximal
	Built-in Power Supply	Power input: 100V – 240V Type/Watt: Medical, 150W
I/O Interface	DC-out 1	12V/15V/19V/24V (80 watts)
	DC-out 2	12V/15V/19V/24V (15 watts)
	USB Type-C	5V/3A (15 watts)
	USB Type-A	Engineering port (for app read/write)
	AC-in	C13 connector
LED Indicator	Normal	Blue: Battery capacity is above 25% (non-AC mode) / battery is fully charged (AC mode) Orange: Battery capacity is 25% – 10% Blinking Orange: Battery capacity is less than 10% Off: sleep mode / battery error / non-IEI battery / without battery
	Charging	Blinking Blue: 0% – 94% charged Blue: 95% – 100% charged
	Full Charge Capacity (FCC)	Battery FCC < 50% - Charging: blinking purple - Fully charged: solid purple
Physical	Weight (Net)	4 kg (with 2 batteries)
	Dimensions (LxWxH)	195 x 180 x 94.1 mm
Environment	Operating Temperature	0°C – 40°C
	Operating Humidity	Relative humidity: 10% – 95%, non-condensing
	Operating Shock	Half-sine wave shock 5G, 11ms, 100 shocks per axis
	Operation Vibration	MIL-STD-810G 514.6C-1
Certification	Battery Pack	UN38.3, UL2054, IEC62133
	EMC & Safety	IEC 60601-1 IEC 60601-1-2 (Edition 4.0)

Ordering Information

Part No.	Description
AXON-mPOWER-R10	100V – 240V AC 150W built-in medical grade power supply, VESA 75/100, two configurable DC outputs, support two TC-202 battery slots, w/o battery, R10

Packing List

Item	Part No.	Q'ty	Remark
Power Cord	32000-000002-RS	1	Round cable; power cord; 2; 1830 mm; (A) plug (16A 250V); (B) connector (10A 250V); European power cord (CEE); CCL; RoHS

AXON-mPOWER I/O Interface

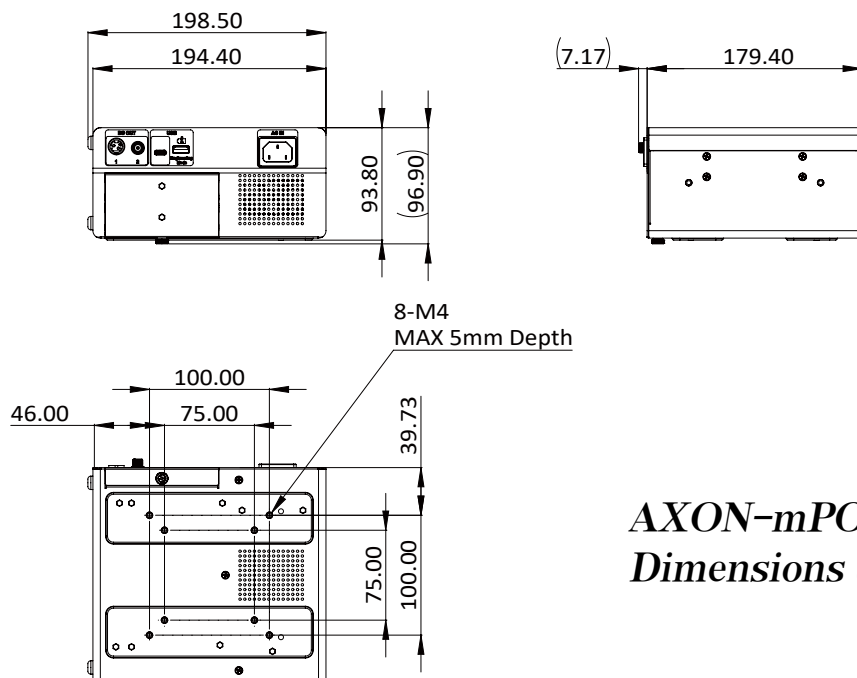
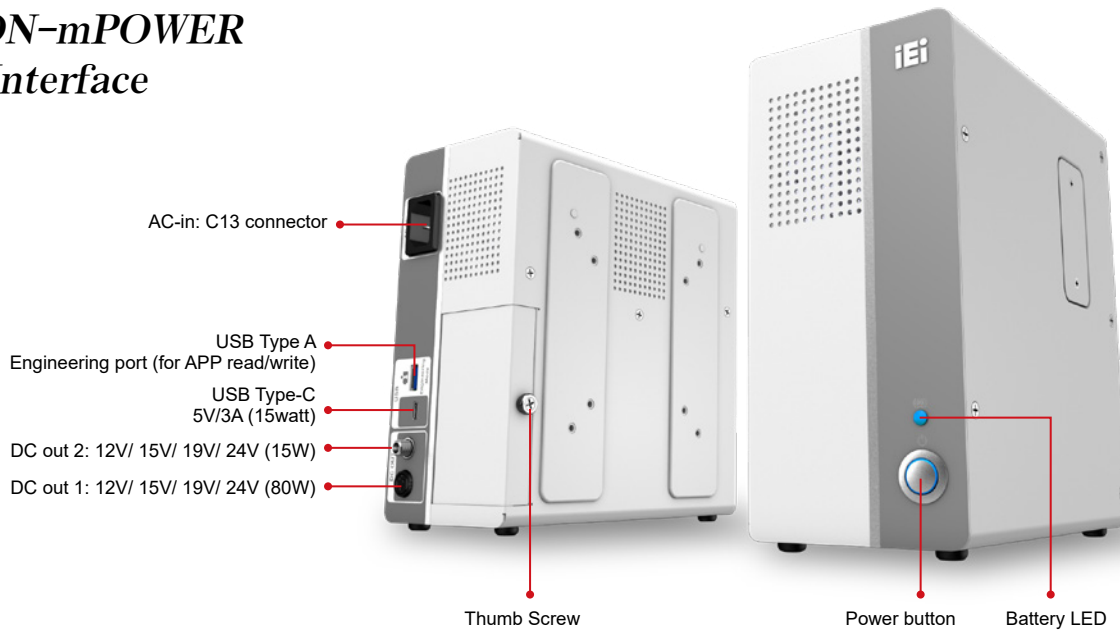

AXON-mPOWER
Dimensions (Unit: mm)

POCm-DOCKING-6BAY-R10



Battery docking station with fast charging which takes only 3.5 hours to charge from 0 to 100%



Specifications

Model		POCm-DOCKING-6BAY-R10
Chassis	Color	White
	Dimension (LxWxH)	274 x 253.3 x 122.85 mm
	Thermal	Active fan
	Chassis Construction	NCT metal housing
Battery	Battery Type	TC-202 (7800mAh)
	Battery Bay	6
	Charge Time	255W, Vin: 100 – 240V AC, Vout: 15V DC 3 – 3.5 hours from 0 – 100% (TC-202)
	Maximum Charge Voltage	12.6V
	Maximum Charge Current	2.2 A/bay
Power	Power Connector	6-pin Molex power connector
	Power Switch	AT power switch
LED Indicator	Normal	1 x Power LED (orange) 6 x Battery LED (green/red)
	Charging	Charging battery: red
	Full Charge Capacity (FCC)	Fully charged battery: green
Physical	Weight (Net)	-
Environment	Operating Temperature	0°C – 40°C
	Storage Temperature	-20°C – 60°C
	Operating Humidity	20 – 90%, non-condensing
	Storage Humidity	10 – 95%, non-condensing
Certification	Battery Pack	-
	EMC & Safety	CE EMC: EN 55032 + EN 55024 FCC part 15B report (one final test mode) UL/CB: 60950-1 & 62368 (covering 2 UL standards/UL 60950-1 + UL 62368) 2 IEC standards/IEC 60950-1 + IEC 62368

Ordering Information

Part No.	Description
POCm-DOCKING-6BAY-R10	6 Bay Smart Charging Docking, with 255 watts PSU, Fast Charging, TC-202, R10

Packing List

Item	Part No.	Q'ty	Remark
Power Adapter	63040-030138-100-RS	1	Adapter Power; MEAN WELL; GST280A15-C6P; GST280A15-C6P; Active PFC; Vin:85 – 264V AC; 138W; Cable=1000mm; Erp(NO LOAD 0.5W); Vout: 15V DC; ATX 2 x 3 Pitch: 4.2mm; CCL; RoHS
Power Cord	32000-000002-RS	1	POWER CORD; 2; 1830mm; (A) PLUG (16A, 250V); (B) CONNECTOR (10A, 250V); EUROPEAN POWER CORD (VDE); CCL; C13; RoHS

Dimensions (Unit: mm)

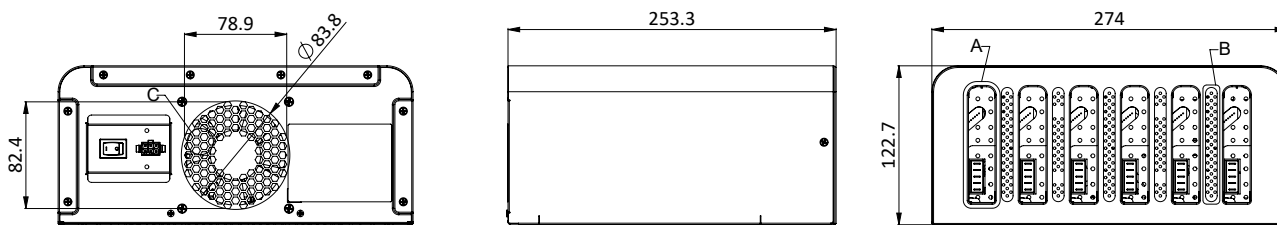

Solution Partner for Healthcare Industry

Medical Certifications



Celebrate Humanity with Technology

BriteMED is dedicated to developing and applying innovative electronic medical solutions that improve clinical workflow and enhance patient care. At BriteMED, all the solutions are designed, tested and refined with the clinical environment in mind. As an affiliate of the IEI Group, a reputed industrial application provider, we leverage the hardware and software strength to provide integrated solution, including medical device, medical display, computing platform, mobile workstation and powering system. The utmost medical solution together with the advanced technology is our commitment for medical professionals. From product design to integration service, we aim to develop reliable and technology-driven solutions that make people's lives better-whether they are doctors, nurses or patients. We believe perfecting those small details touches our customers and their individual requests.



Medical Monitor

Multi-modality display for endoscopy application and surgical environment

The BriteMED® medical display supports multiple digital and analog inputs, enabling the connection to the state-of-the-art devices without extra efforts. The DICOM/GAMMA compliance and adjustable color temperature ensure accurate and artifact-free imaging quality, to help surgeons make decision during operation. The special-coating glass allows precise imaging view experience in the operation theater and facilitates clean purpose for infection control.



Medical Computer Cart

A wide range of medication and documentation carts for ward rounds

The BriteMED® Medical Computer Cart can be integrated with the battery medical panel PCs, providing an all-in-one solution for EHR workstation. For various hospital requirements, a range of colors and accessories can be chosen to maximize the flexibility for different applications.

BriteMED® 21" Medical Monitor

Multi-Interfaces for Endoscopy Examination

Powered by BriteMED



* Stand is optional

Benefits



Versatile Connection

Multiple inputs enable flexible connection by applications: VGA & DVI input for general connection, traditional analog input/output for replacing CRT monitor with old endoscopy system.



Accurate Image Viewing

The DICOM and GAMMA compliance ensures optimized color and grey scale reproduction, bringing the accurate and quality imaging for further diagnosis.



Easy for Maintenance

The smart OSD allows quick monitor setting by PC. The optional GPIO port is reserved for developing customized functions and facilitating maintenance purpose.



Easy Installation

The VESA 75/100 compliance supports easy installation in the space-limited examination room, on the cart, surgical boom arm, or other mounting kits

Selection Guide

	With VGA & DVI input for general connection	With analog video input for traditional system	With 3G-SDI input for advanced system
Without HDMI Input/output	MMS-21C	MMS-21CA	MMS-21CS MMS-21CAS
With HDMI Input/output for PIP/PBP Display	MMS-21CH	MMS-21CAH	MMS-21CHS MMS-21CAHS

Specifications

Model		MMS-21C	MMS-21CA	MMS-21CH	MMS-21CAH	MMS-21CS	MMS-21CAS	MMS-21CHS	MMS-CAHS	
Description		General VGA, DVI inputs	VGA, DVI, and multiple analog inputs	VGA, DVI, and HDMI inputs	VGA, DVI, analog, and HDMI inputs	VGA, DVI, and 3G-SDI inputs	Analog and 3G-SDI inputs	HDMI and 3G-SDI inputs	Analog, HDMI, and 3G-SDI inputs	
Picture Performance	LCD Size	21.5" (16:9)								
	Resolution	1920 (W) x 1080 (H) pixels								
	Brightness (max.)	250 nits (typical)								
	Contrast Ratio	5000:1 (typical)								
	Viewing Angle (H/V)	178° / 178° (typical)								
	Color Temperature	Factory calibrated 4500K, 5500K, 6500K, 7500K								
	Gamma Correction	Factory calibrated gamma 2.0 & DICOM								
Function	Function Keys	1 x OSD rotary knob 1 x Input source quick selection 1 x Monitor sleep								
Input	VGA (DB-15)	1								
	DVI-D	1								
	HDMI	N/A	N/A	1	1	N/A	N/A	1	1	
	Component	N/A	BNC x 5 (Y/Pb/Pr, R/Gs/B, R/G/B/C-Sync, R/G/B/H-Sync/V-Sync)	N/A	BNC x 5 (Y/Pb/Pr, R/Gs/B, R/G/B/C-Sync, R/G/B/H-Sync/V-Sync)	N/A	BNC x 5 (Y/Pb/Pr, R/Gs/B, R/G/B/C-Sync, R/G/B/H-Sync/V-Sync)	N/A	BNC x 5 (Y/Pb/Pr, R/Gs/B, R/G/B/C-Sync, R/G/B/H-Sync/V-Sync)	
	CVBS	N/A	BNC x 1 (NTSC, PAL)	N/A	BNC x 1 (NTSC, PAL)	N/A	BNC x 1 (NTSC, PAL)	N/A	BNC x 1 (NTSC, PAL)	
	S-Video	N/A	1	N/A	1	N/A	1	N/A	1	
	3G-SDI	N/A	N/A	N/A	N/A	1	1	1	1	
	Audio	Phone jack x 1								
Output	HDMI	N/A	N/A	1, loop through	1, loop through	N/A	N/A	1, loop through	1, loop through	
	Component	N/A	BNC x 5, loop through (Y/Pb/Pr, R/Gs/B, R/G/B/C-Sync, R/G/B/H-Sync/V-Sync)	N/A	BNC x 5, loop through (Y/Pb/Pr, R/Gs/B, R/G/B/C-Sync, R/G/B/H-Sync/V-Sync)	N/A	BNC x 5, loop through (Y/Pb/Pr, R/Gs/B, R/G/B/C-Sync, R/G/B/H-Sync/V-Sync)	N/A	BNC x 5, loop through (Y/Pb/Pr, R/Gs/B, R/G/B/C-Sync, R/G/B/H-Sync/V-Sync)	
	CVBS	N/A	BNC x 1, loop through (NTSC, PAL)	N/A	BNC x 1, loop through (NTSC, PAL)	N/A	BNC x 1, loop through (NTSC, PAL)	N/A	BNC x 1, loop through (NTSC, PAL)	
	S-Video	N/A	1, loop through	N/A	1, loop through	N/A	1, loop through	N/A	1, loop through	
	3G-SDI	N/A	N/A	N/A	N/A	1, loop through	1, loop through	1, loop through	1, loop through	
	Audio	0.8W x 2								
General	Power Requirement	10V~28V DC input								
	Power Adaptor	Medical grade power adaptor: input: 100-240V AC 50-60Hz; output: 12V DC/5.42A								
	Dimensions (L x W x H)	530 x 325 x 53 mm								
	Weight	6.6 kg								
	Mounting Standard	VESA 75 x 75 mm / 100 x 100 mm								
Environment	Operating Temperature	0°C~40°C								
	Operating Humidity	10%~90% (non-condensing)								
	Storage Temperature	-20°C ~60°C								
	Storage Humidity	10%~90% (non-condensing)								
Certifications	Certifications & Compliance	ANSI/AAMI ES60601-1, EN60601-1, CAN/CSA C22.2 No. 60601-1, and FCC Class B part 18								
Package Content	Monitor	1	1	1	1	1	1	1	1	
	Power Adaptor	1	1	1	1	1	1	1	1	
	Power Cord	1	1	1	1	1	1	1	1	
	Grounding Cable	1	1	1	1	1	1	1	1	
	VGA Cable	1	1	1	1	1	1	1	1	
	DVI Cable	1	1	1	1	1	1	1	1	
	HDMI Cable	N/A	N/A	1	1	N/A	N/A	1	1	
	USB Cable	1	1	1	1	1	1	1	1	
User Manual (USB flash drive)	1	1	1	1	1	1	1	1		

Dimensions (unit: mm)

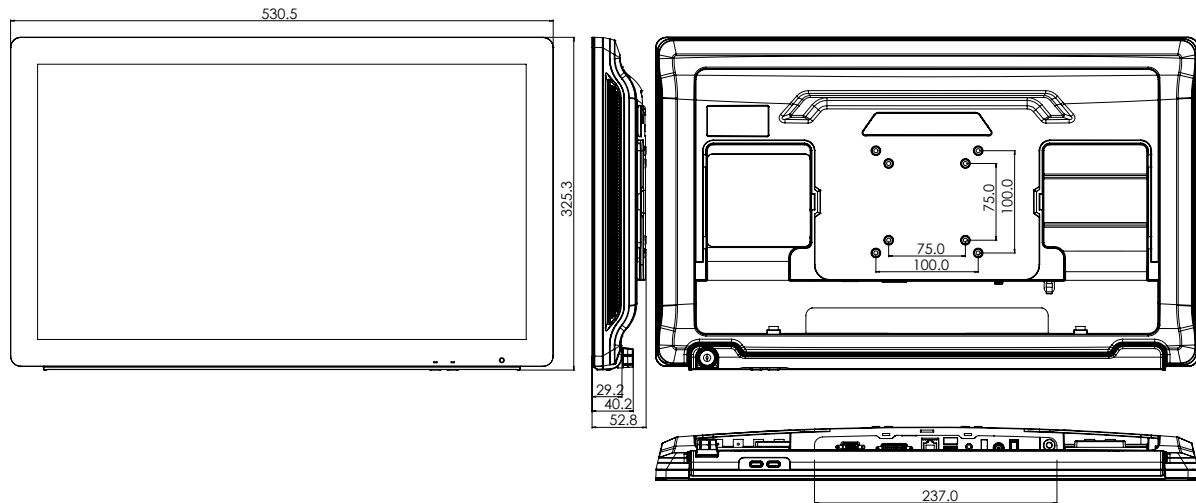

Signal Interface

MMS-21C

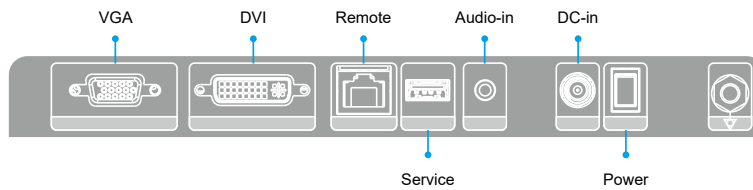

MMS-21CA

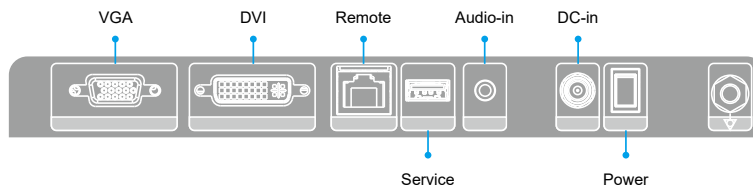
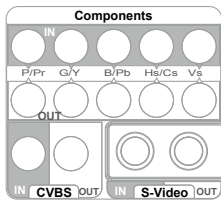

MMS-21CH

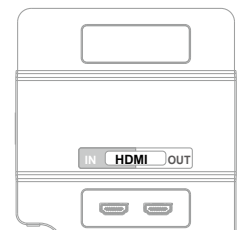
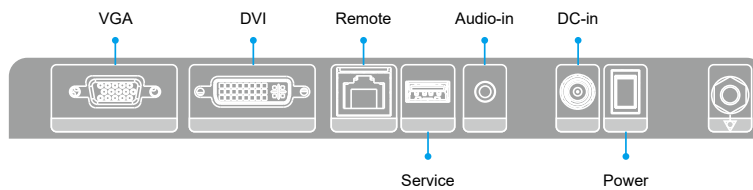

MMS-21CAH

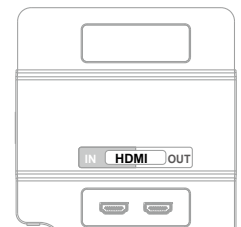
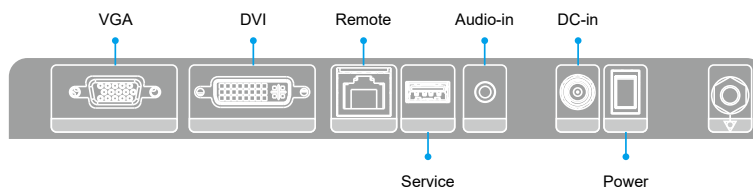
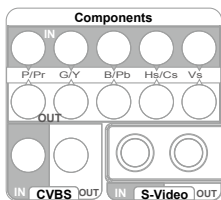

Signal Interface

MMS-21CS

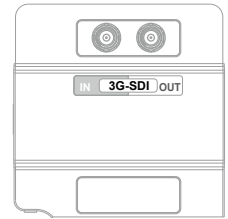
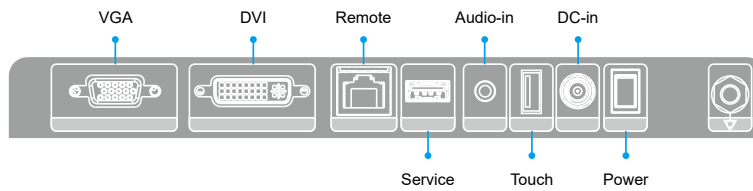

MMS-21CAS

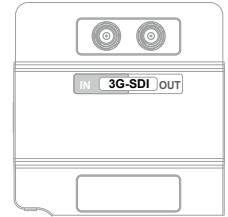
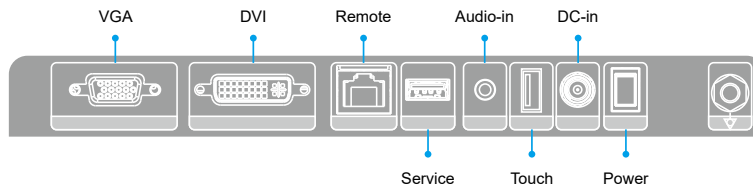

MMS-21CHS

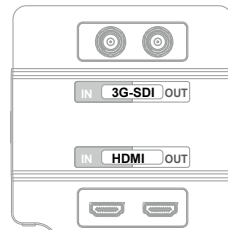
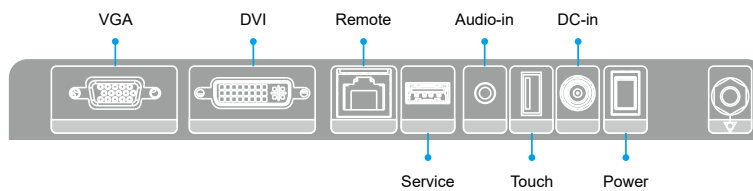

MMS-21CAHS

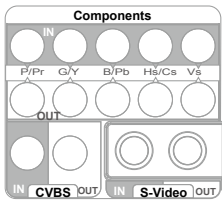
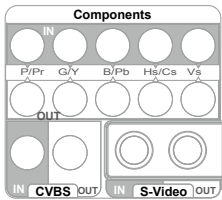
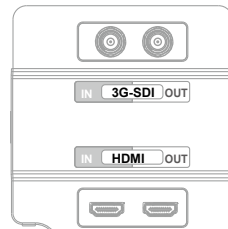
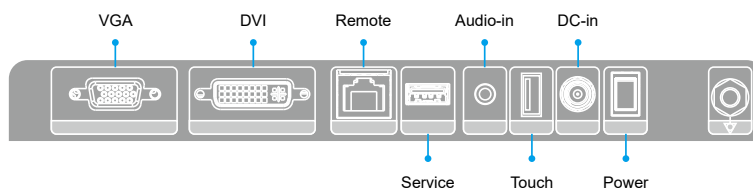

Ordering Information

Part No.	Description
MMS-21C-R11	21.5", White, 1920x1080, VGA/DVI-D, 100~240 VAC to 12V DC power adaptor
MMS-21CA-R11	21.5", White, 1920x1080, VGA/DVI-D/Component/CVBS/S-Video input, 100~240 VAC to 12V DC power adaptor
MMS-21CH-R11	21.5", White, 1920x1080, VGA/DVI-D/HDMI input, 100~240 VAC to 12V DC power adaptor
MMS-21CAH-R11	21.5", White, 1920x1080, VGA/DVI-D/Component/CVBS/S-Video/HDMI input, 100~240 VAC to 12V DC power adaptor
MMS-21CS-R11	21.5", White, 1920x1080, VGA/DVI-D/3G SDI input, 100~240 VAC to 12V DC power adaptor
MMS-21CAS-R11	21.5", White, 1920x1080, VGA/DVI-D/Component/CVBS/S-Video/3G SDI input, 100~240 VAC to 12V DC power adaptor
MMS-21CHS-R11	21.5", White, 1920x1080, VGA/DVI-D/HDMI/3G SDI input, 100~240 VAC to 12V DC power adaptor
MMS-21CAHS-R11	21.5", White, 1920x1080, VGA/DVI-D/Component/CVBS/S-Video/HDMI/3G SDI input, 100~240 VAC to 12V DC power adaptor

Factory Options

Part No.	Description
STAND-DWH-R10	VESA 75/100 stand, supports up to 15 kg, white
AFLWK-19B	VESA 100 wall mount kit, supports up to 7.5 kg, silver

BriteMED[®] 21" Medical Monitor

Touch Function for Medical Modality Control Terminal

Powered by BriteMED



* Stand is optional

Benefits



Versatile Connection

Multiple analog and digital inputs/outputs, including HDMI loop-through, allow flexible connections and image sharing simultaneously.



Intuitive Touch Operation

The PCAP multi-touch screen enables easy operation even in latex gloves, facilitating procedure of image-viewing and information accessing.



Easy to Clean

The special-coating glass not only ensures precise image viewing experience under strong OR lighting but also brings easy-to-clean advantage required for infection control.



Accurate Image Viewing

The DICOM and GAMMA compliance ensures precise color and grey scale reproduction, satisfying medical imaging requirement and assisting further diagnosis.

Selection Guide

	With VGA & DVI input for general connection	With analog video input for traditional system	With 3G-SDI input for advanced system
Without HDMI Input/output	MMS-21CT	MMS-21CAT	MMS-21CST MMS-21CAST
With HDMI Input/output for PIP/PBP Display	MMS-21CHT	MMS-21CAHT	MMS-21CHST MMS-21CAHST

Specifications

Model		MMS-21CT	MMS-21CAT	MMS-21CHT	MMS-21CAHT	MMS-21CST	MMS-21CAST	MMS-21CHST	MMS-21CAHST
Description		Touch-screen model with general VGA & DVI inputs	Touch-screen model with analog inputs	Touch-screen model with HDMI input	Touch-screen model with analog and HDMI inputs	Touch-screen model with VGA, DVI, and 3G-SDI inputs	Touch-screen model with analog, and 3G-SDI inputs	Touch-screen model with HDMI, and 3G-SDI inputs	Touch-screen model with analog HDMI, and 3G-SDI inputs
Picture Performance	LCD Size	21.5" (16:9)							
	Resolution	1920 (W) x 1080 (H) pixels							
	Brightness (max.)	250 nits (typical)							
	Contrast Ratio	5000:1 (typical)							
	Viewing Angle (H/V)	178° / 178° (typical)							
	Color Temperature	Factory calibrated 4500K, 5500K, 6500K, 7500K							
	Gamma Correction	Factory calibrated gamma 2.0 & DICOM							
Function	Touch Screen	Projected capacitive touchscreen (USB interface)							
	Function Keys	1 x OSD rotary knob 1 x Input source quick selection 1 x Monitor sleep							
Input	VGA (DB-15)	1							
	DVI-D	1							
	HDMI	N/A	N/A	1	1	N/A	N/A	1	1
	Component	N/A	BNC x 5 (Y/Pb/ Pr, R/Gs/B, R/G/ B/ C-Sync, R/G/B/ H-Sync/V-Sync)	N/A	BNC x 5 (Y/Pb/ Pr, R/Gs/B, R/G/ B/ C-Sync, R/G/B/ H-Sync/V-Sync)	N/A	BNC x 5 (Y/Pb/ Pr, R/Gs/B, R/G/ B/ C-Sync, R/G/B/ H-Sync/V-Sync)	N/A	BNC x 5 (Y/Pb/ Pr, R/Gs/B, R/G/ B/ C-Sync, R/G/B/ H-Sync/V-Sync)
	CVBS	N/A	BNC x 1 (NTSC, PAL)	N/A	BNC x 1 (NTSC, PAL)	N/A	BNC x 1 (NTSC, PAL)	N/A	BNC x 1 (NTSC, PAL)
	S-Video	N/A	1	N/A	1	N/A	1	N/A	1
	3G-SDI	N/A	N/A	N/A	N/A	1	1	1	1
	Audio	Phone jack x 1							
Output	HDMI	N/A	N/A	1, loop through	1, loop through	N/A	N/A	1, loop through	1, loop through
	Component	N/A	BNC x 5, loop through (Y/Pb/ Pr, R/Gs/B, R/G/ B/ C-Sync, R/G/B/ H-Sync/V-Sync)	N/A	BNC x 5, loop through (Y/Pb/ Pr, R/Gs/B, R/G/ B/ C-Sync, R/G/B/ H-Sync/V-Sync)	N/A	BNC x 5, loop through (Y/Pb/ Pr, R/Gs/B, R/G/ B/ C-Sync, R/G/B/ H-Sync/V-Sync)	N/A	BNC x 5, loop through (Y/Pb/ Pr, R/Gs/B, R/G/ B/ C-Sync, R/G/B/ H-Sync/V-Sync)
	CVBS	N/A	BNC x 1, loop through (NTSC, PAL)	N/A	BNC x 1, loop through (NTSC, PAL)	N/A	BNC x 1, loop through (NTSC, PAL)	N/A	BNC x 1, loop through (NTSC, PAL)
	S-Video	N/A	1, loop through	N/A	1, loop through	N/A	1, loop through	N/A	1, loop through
	3G-SDI	N/A				1, loop through			
	Audio	0.8W x 2							
General	Power Requirement	10V~28V DC input							
	Power Adaptor	Medical grade power adaptor: input:100-240V AC 50-60Hz; output: 12V DC/5.42A							
	Dimensions (L x W x H)	530 x 325 x 53 mm							
	Weight	6.6 kg							
	Mounting Standard	VESA 75 x 75 mm / 100 x 100 mm							
Environment	Operating Temperature	0°C~40°C							
	Operating Humidity	10%~90% (non-condensing)							
	Storage Temperature	-20°C ~60°C							
	Storage Humidity	10%~90% (non-condensing)							
Certifications & Compliance	ANSI/AAMI ES60601-1, EN60601-1, CAN/CSA C22.2 No. 60601-1, and FCC Class B part 18								
Package Content	Monitor	1	1	1	1	1	1	1	1
	Power Adaptor	1	1	1	1	1	1	1	1
	Power Cord	1	1	1	1	1	1	1	1
	Grounding Cable	1	1	1	1	1	1	1	1
	VGA Cable	1	1	1	1	1	1	1	1
	DVI Cable	1	1	1	1	1	1	1	1
	HDMI Cable	N/A	N/A	1	1	N/A	N/A	1	1
	Touchscreen Cable	1	1	1	1	1	1	1	1
	USB Cable	1	1	1	1	1	1	1	1
	User Manual (USB flash drive)	1	1	1	1	1	1	1	1

Dimensions (unit: mm)

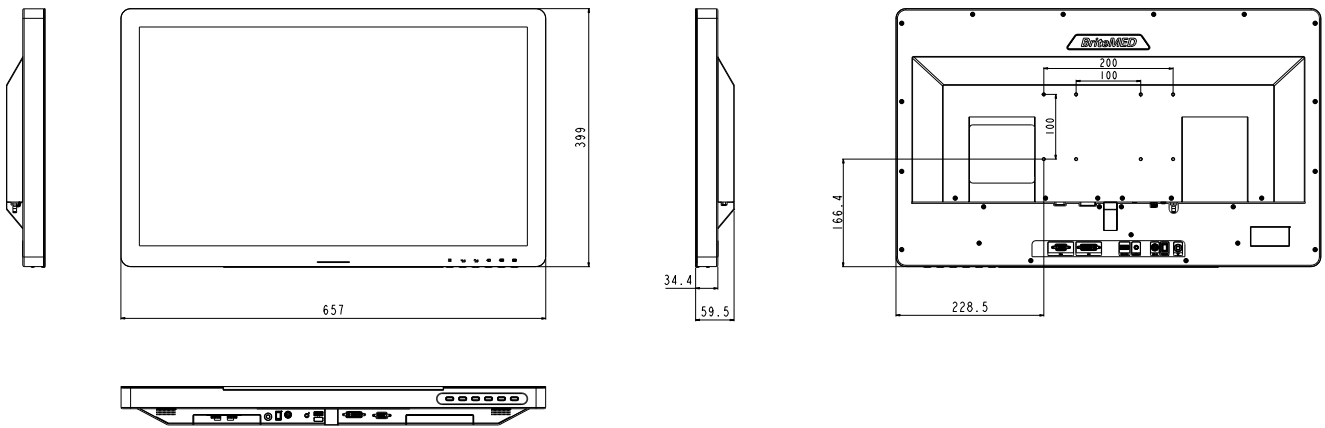

Signal Interface

MMS-21CT

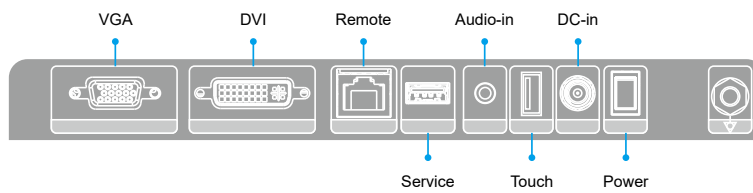

MMS-21CAT

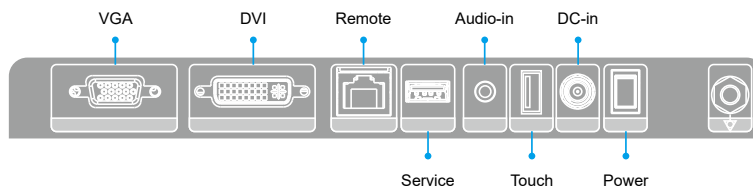
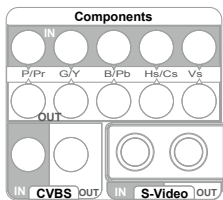

MMS-21CHT

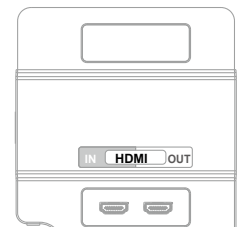
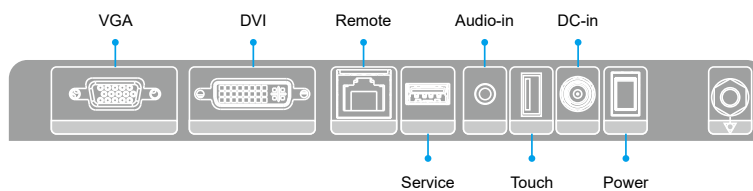

MMS-21CAHT

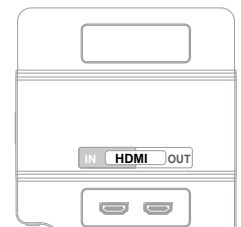
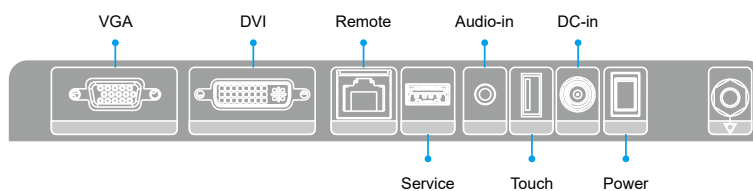
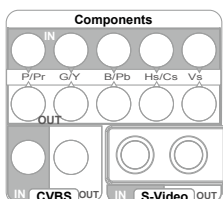

Signal Interface

MMS-21CST

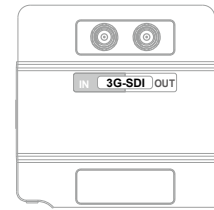
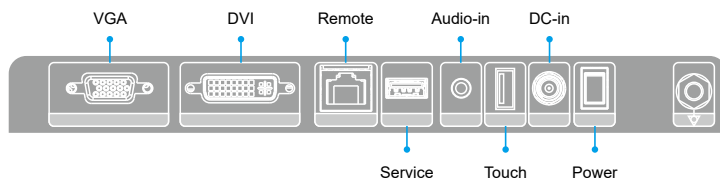

MMS-21CAST

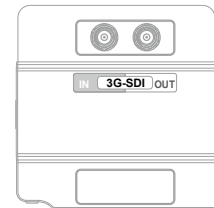
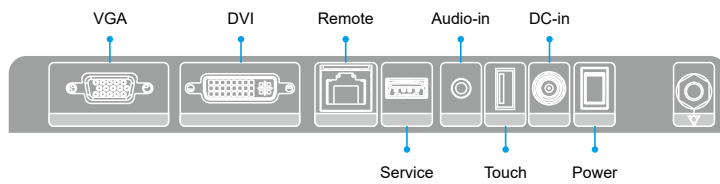

MMS-21CHST

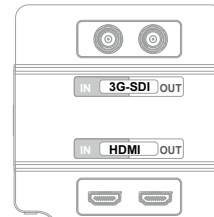
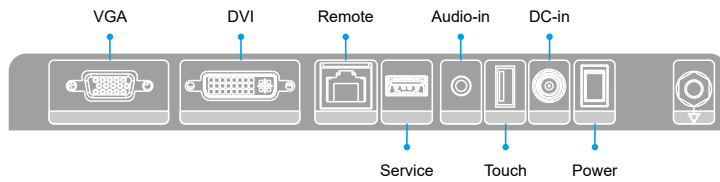

MMS-21CAHST

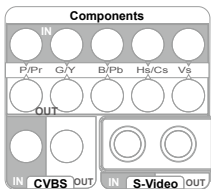
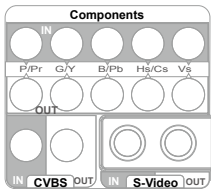
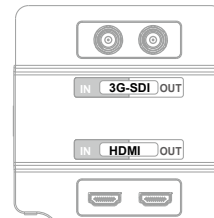
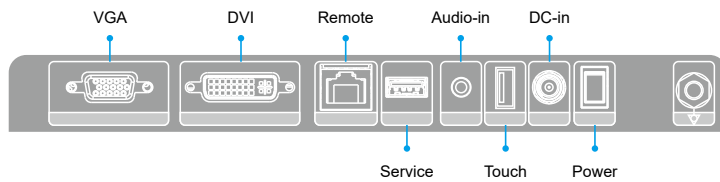

Ordering Information

Part No.	Description
MMS-21CT-R11	21.5", White, 1920x1080, VGA/DVI-D input, P-CAP Touchscreen, 100~240 VAC to 12V DC power adaptor
MMS-21CAT-R11	21.5", White, 1920x1080, VGA/DVI-D/Component/CVBS/S-Video input, P-CAP Touchscreen, 100~240 VAC to 12V DC power adaptor
MMS-21CHT-R11	21.5", White, 1920x1080, VGA/DVI-D/HDMI input, P-CAP Touchscreen, 100~240 VAC to 12V DC power adaptor
MMS-21CAHT-R11	21.5", White, 1920x1080, VGA/DVI-D/Component/CVBS/S-Video/HDMI input, P-CAP Touchscreen, 100~240 VAC to 12V DC power adaptor
MMS-21CST-R11	21.5", White, 1920x1080, VGA/DVI-D/3G SDI input P-CAP Touchscreen, 100~240 VAC to 12V DC power adaptor
MMS-21CAST-R11	21.5", White, 1920x1080, VGA/DVI-D/Component/CVBS/S-Video/3G SDI input P-CAP Touchscreen, 100~240 VAC to 12V DC power adaptor
MMS-21CHST-R11	21.5", White, 1920x1080, VGA/DVI-D/HDMI/3G SDI input P-CAP Touchscreen, 100~240 VAC to 12V DC power adaptor
MMS-21CAHST-R11	21.5", White, 1920x1080, VGA/DVI-D/Component/CVBS/S-Video/HDMI/3G SDI input P-CAP Touchscreen, 100~240 VAC to 12V DC power adaptor

Factory Options

Part No.	Description
STAND-DWH-R10	VESA 75/100 stand, supports up to 15 kg, white
AFLWK-19B	VESA 100 wall mount kit, supports up to 7.5 kg, silver

BriteMED® 27" Medical Monitor

High Brightness for Surgical Imaging

Powered by BriteMED



* Stand is optional

Benefits



Versatile Connection

Multiple inputs enable flexible connection by applications: VGA & DVI input for general connection, HDMI input/output featuring PIP/PBP function for multi-modality, and optional 3G-SDI module for advanced endoscopy system.



Accurate Image Viewing

The compliance with DICOM/ GAMMA ensures optimized color and gray scale reproduction for best image accuracy.



Exceptional Clarity

The 700-nits high brightness enhances clarity and details for both color and grayscale images.



Multimodality Imaging

The picture-in-picture (PIP) and picture-by-picture settings allow multimodality display capability for various image combinations.

Selection Guide

	With VGA & DVI input for general connection	With analog video input for traditional system	With 3G-SDI input for advanced system
Without HDMI Input/output	MMS-27C	MMS-27CA	MMS-27CS MMS-27CAS
With HDMI Input/output for PIP/PBP Display	MMS-27CH	MMS-27CAH	MMS-27CHS MMS-27CAHS

Specifications

Model		MMS-27C	MMS-27CA	MMS-27CH	MMS-27CAH	MMS-27CS	MMS-27CAS	MMS-27CHS	MMS-27CAHS
Description		General VGA, DVI inputs	Multiple analog inputs	VGA, DVI, and HDMI inputs	VGA, DVI, analog, and HDMI inputs	VGA, DVI, and 3G-SDI inputs	Analog and 3G-SDI inputs	HDMI and 3G-SDI inputs	Analog, HDMI, and 3G-SDI inputs
Picture Performance	LCD Size	27" (16:9)							
	Resolution	1920 (W) x 1080 (H) pixels							
	Brightness (max.)	700 nits (typical)							
	Contrast Ratio	1000:1 (typical)							
	View Angle (H/V)	178° / 178° (typical)							
	Color Temperature	Factory calibrated 5500K, 6500K, 7500K, 9300K							
	Gamma Correction	Factory calibrated gamma 2.0 & DICOM							
Function	Function Keys				1 x MENU 1 x Input source 1 x Custom input	1 x Backlight up /+ 1 x Backlight down /- 1 x Image size adjustment			
Input	VGA (DB-15)	1							
	DVI-D	1							
	HDMI	N/A	N/A	1	1	N/A	N/A	1	1
	Component	N/A	BNC x 5 (Y/Pb/Pr, R/Gs/B, R/G/B/C-Sync, R/G/B/H-Sync/V-Sync)	N/A	BNC x 5 (Y/Pb/Pr, R/Gs/B, R/G/B/C-Sync, R/G/B/H-Sync/V-Sync)	N/A	BNC x 5 (Y/Pb/Pr, R/Gs/B, R/G/B/C-Sync, R/G/B/H-Sync/V-Sync)	N/A	BNC x 5 (Y/Pb/Pr, R/Gs/B, R/G/B/C-Sync, R/G/B/H-Sync/V-Sync)
	CVBS	N/A	BNC x 1 (NTSC, PAL)	N/A	BNC x 1 (NTSC, PAL)	N/A	BNC x 1 (NTSC, PAL)	N/A	BNC x 1 (NTSC, PAL)
	S-Video	N/A	1	N/A	1	N/A	1	N/A	1
	3G-SDI	1							
	Audio	Phone jack x 1							
Output	HDMI	N/A	N/A	1, loop through	1, loop through	N/A	N/A	1, loop through	1, loop through
	Component	N/A	BNC x 5, loop through (Y/Pb/Pr, R/Gs/B, R/G/B/C-Sync, R/G/B/H-Sync/V-Sync)	N/A	BNC x 5, loop through (Y/Pb/Pr, R/Gs/B, R/G/B/C-Sync, R/G/B/H-Sync/V-Sync)	N/A	BNC x 5, loop through (Y/Pb/Pr, R/Gs/B, R/G/B/C-Sync, R/G/B/H-Sync/V-Sync)	N/A	BNC x 5, loop through (Y/Pb/Pr, R/Gs/B, R/G/B/C-Sync, R/G/B/H-Sync/V-Sync)
	CVBS	N/A	BNC x 1, loop through (NTSC, PAL)	N/A	BNC x 1, loop through (NTSC, PAL)	N/A	BNC x 1, loop through (NTSC, PAL)	N/A	BNC x 1, loop through (NTSC, PAL)
	S-Video	N/A	1, loop through	N/A	1, loop through	N/A	1, loop through	N/A	1, loop through
	3G-SDI	N/A	N/A	N/A	N/A	1, loop through			
	Audio	0.8W x 2							
General	Power Requirement	10V~28V DC input							
	Power Adaptor	Medical grade power adaptor: input: 100-240V AC 50-60Hz; output: 12V DC/7.5A							
	Dimensions (L x W x H)	657 x 399 x 59.5 mm							
	Weight	10 kg							
	Mounting Standard	VESA 100 x 100 mm / 200 x 100 mm							
Environment	Operating Temperature	0°C~40°C							
	Operating Humidity	10%~90% (non-condensing)							
	Storage Temperature	-20°C ~60°C							
	Storage Humidity	10%~90% (non-condensing)							
	Certifications & Compliance	ANSI/AAMI ES60601-1, EN60601-1, CAN/CSA C22.2 No. 60601-1, and FCC Class B part 18							
Package Content	Monitor	1	1	1	1	1	1	1	1
	Power Adaptor	1	1	1	1	1	1	1	1
	Power Cord	1	1	1	1	1	1	1	1
	Grounding Cable	1	1	1	1	1	1	1	1
	VGA Cable	1	1	1	1	1	1	1	1
	DVI Cable	1	1	1	1	1	1	1	1
	HDMI Cable	N/A	N/A	1	1	N/A	N/A	1	1
	USB Cable	1	1	1	1	1	1	1	1
User Manual (USB flash drive)	1	1	1	1	1	1	1	1	

Dimensions (unit: mm)

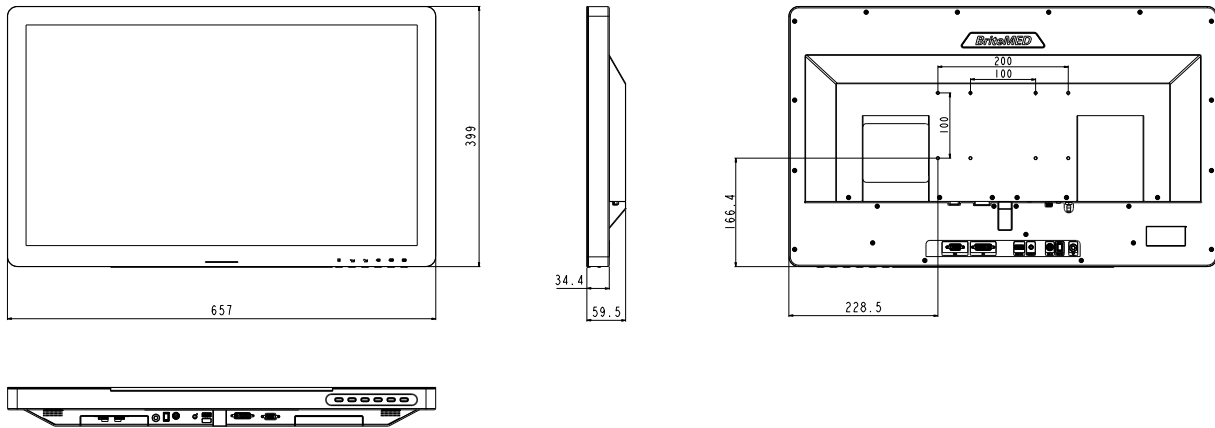

Signal Interface

MMS-27C

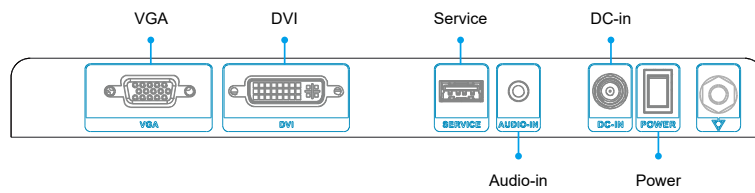

MMS-27CA

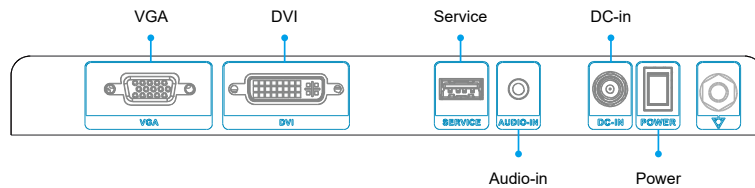
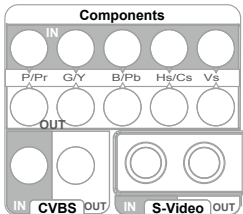

MMS-27CH

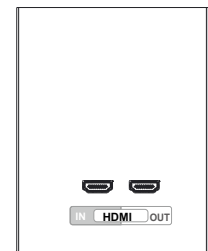
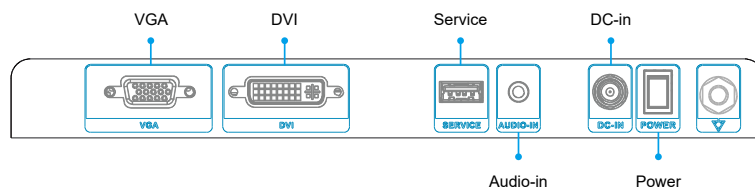

MMS-27CAH

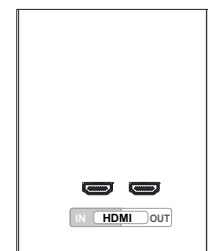
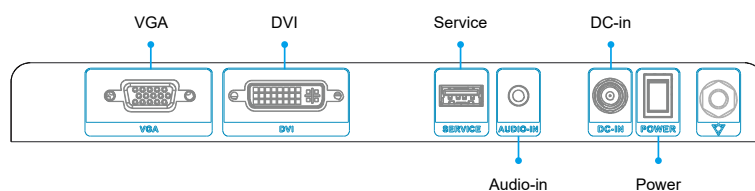
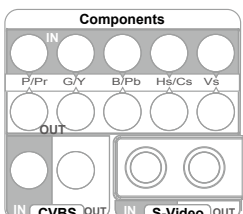

Signal Interface

MMS-27CS

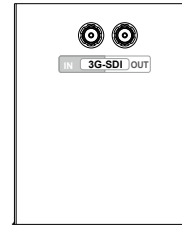
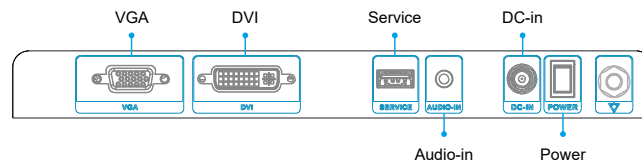

MMS-27CAS

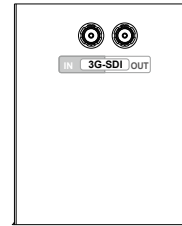
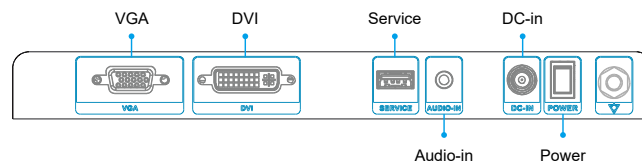

MMS-27CHS

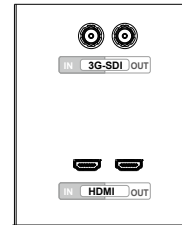
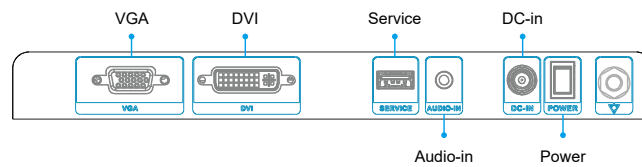

MMS-27CAHS

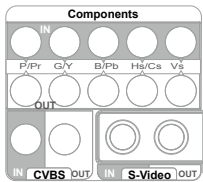
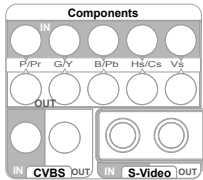
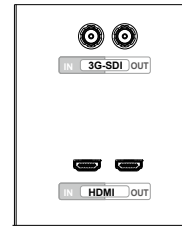
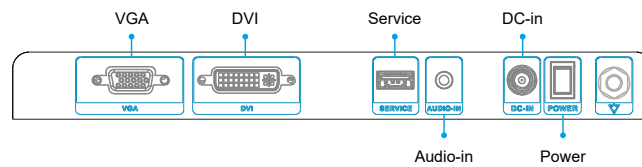

Ordering Information

Part No.	Description
MMS-27C-R10	27" 1920x1080 color monitor, VGA/DVI-D input, 100-240V AC to 12V DC power adaptor
MMS-27CA-R10	27" 1920x1080 color monitor, VGA/DVI-D/Component/CVBS/S-Video input, 100-240V AC to 12V DC power adaptor
MMS-27CH-R10	27" 1920x1080 color monitor, VGA/DVI-D/HDMI input, 100-240V AC to 12V DC power adaptor
MMS-27CAH-R10	27" 1920x1080 color monitor, VGA/DVI-D/Component/CVBS/S-Video/HDMI input, 100-240V AC to 12V DC power adaptor
MMS-27CS-R10	27" 1920x1080 color monitor, VGA/DVI-D/3G SDI input, 100~240 VAC to 12V DC power adaptor
MMS-27CAS-R10	27" 1920x1080 color monitor, VGA/DVI-D/Component/CVBS/S-Video/3G SDI input, 100~240 VAC to 12V DC power adaptor
MMS-27CHS-R10	27" 1920x1080 color monitor, VGA/DVI-D/HDMI/3G SDI input, 100~240 VAC to 12V DC power adaptor
MMS-27CAHS-R10	27" 1920x1080 color monitor, VGA/DVI-D/Component/CVBS/S-Video/HDMI/3G SDI input, 100~240 VAC to 12V DC power adaptor

Factory Options

Part No.	Description
STAND-DWH-R10	VESA 75/100 stand, supports up to 15 kg, white
WK-E35M-R10	VESA 100/200/200x100 wall mount kit, supports up to 35 kg, silver

BriteMED[®] Medical Computer Cart

Powered by BriteMED

BriteMED[®] Medical Computer Carts are in wide selection for medication, ICU, and documentation purpose. Designed with aluminum-alloy structure and ABS working table feature durability and easy-to-clean advantage. When integrating with medical panel PC, the intelligent medical workstation creates clinical mobility that streamline the hospital workflow and improve ward-round efficiency.



Model No.	pCART-N1	pCART-N3	pCART-D1	
Description	Ergonomic for medication use	Small and Compact for use in limited space	Elegant design for documentation purpose	
Size (L x W x H)	68 x 54 x 103 cm	46 x 51 x 94 cm	54 x 52 x 79.5~109.5 cm	
Working Table Dimensions (L x W)	59 x 45 cm		45 x 54 cm	
Side Table Loading Weight (max.)	8 kg		N/A	
Supported Arm Loading Weight (max.)	12 kg		8 kg	
Standard Drawer Configuration	Total Height	27"	24"	N/A
	3" keyboard drawer	1	1	N/A
	3" drawer/ABS tray	1	2	N/A
	3" medication drawer	3	N/A	N/A
	6" drawer	2	1	N/A
	9" drawer	N/A	1	N/A
Mouse Holder	N/A		1	
Document Basket	N/A		1	
Barcode Reader Holder	N/A		1	
Wheels	5"	4"	4"	

*Accessories and panel PC are optional